



Multipette[®] stream Multipette[®] Xstream

Bedienungsanleitung · Operating Manual

eppendorf

Multipette® stream / Xstream – Inhalt / Contents

Bedienungsanleitung.....	3
Operating Manual.....	47

US-Patente:

5,620,660

5,620,661

Für den Abwerfer ist ein Patent angemeldet.

Für den Modus Titration ist ein Patent angemeldet.

Für die gesamte Multipette® stream / Xstream ist ein Geschmacksmuster angemeldet.

US Patents:

5,620,660

5,620,661

There is a patent pending for the ejector.

There is a patent pending for Titration mode.

There is a design patent pending for the the entire Multipette® stream / Xstream.

US Design Patents:

Combitip Plus 0.1 mL 384,163

Combitip Plus 2.5 mL 384,162

Combitip Plus 10 mL 387,426

Multipette® stream / Xstream – Table of Contents

Table of Contents

1	User Instructions	49
1.1	Use of operating manual	49
1.2	Meaning of warnings	49
1.3	Glossary	50
2	Product Description	53
2.1	Front view Multipette® Xstream	53
2.2	Side view Multipette® Xstream	54
2.3	Delivery package	55
2.4	Product Properties	56
2.4.1	Application area.....	56
2.4.2	Dispensing tasks	56
2.4.3	Materials	56
2.4.4	Eppendorf accessories.....	57
2.4.5	Guarantee and warranty.....	57
3	Safety.....	58
3	General Safety Information.....	58
	Handling	58
	Care and maintenance	59
	Power supply and rechargeable battery	59
4	Startup.....	60
4.1	Power supply assembly	60
4.2	Insertion and charging of Li-ion battery	61
4.3	Accessories	62
	Overview Combitips plus	62
	Table of volume ranges for Combitips plus with Multipette stream	62
	Assembly of Combitip plus with Adapter plus	63
	Installation of Combitip plus.....	63
	Charging stand	64
	Combilong	64
	Combitip rack.....	64
5	Operation	65
5.1	Overview of operator control elements	65
5.2	Application examples	67
5.2.1	"Dis" Dispensing mode	67
5.2.1.1	Editing of "Dis" mode.....	67
5.2.1.2	Execution of "Dis" mode	70
5.2.2	"Pip" Pipetting mode.....	72
5.2.2.1	Editing "Pip" mode.....	72
5.2.2.2	Executing "Pip" mode	72
5.2.3	"Ads" Automatic Dispensing mode.....	73
5.2.3.1	Editing "Ads" mode.....	73
5.2.3.2	Execution of "Ads" mode.....	73

Multipette® stream / Xstream – Table of Contents

5.3	Example applications for the Multipette Xstream modes	75
5.3.1	"Asp" Aspirate mode with the Multipette Xstream	75
5.3.1.1	Editing "Asp" mode	75
5.3.1.2	Executing "Asp" mode	76
5.3.2	"Seq" Sequential Dispensing mode	78
5.3.2.1	Editing "Seq" mode	79
5.3.2.2	Executing "Seq" mode	80
5.3.3	"Ttr" Titration mode with the Multipette Xstream	80
5.3.3.1	Editing "Ttr" mode	80
5.3.3.2	Executing "Ttr" mode	81
5.4	Device Parameters	82
6	Troubleshooting	83
6.1	Troubleshooting table	83
	If there is doubt that dispensing data are correct	84
7	Maintenance	85
7.1	Cleaning	85
	Care and maintenance	85
7.2	Disinfection / Decontamination	85
7.3	Decontamination before dispatch	85
8	Technical Data	86
8.1	Technical Data	86
9	Ordering Information	88
9.1	Ordering Information	88
10	Storage and Disposal	89
10.1	Storage	89
10.2	Disposal	89
11	EC Conformity Declaration	90
	EC Conformity Declaration	90

Multipette® stream / Xstream – 1 User Instructions

1.1 Use of operating manual

This operating manual forms part of the dispensing devices Multipette stream and Multipette Xstream.

Separate reference is made in the text to usage options which are only available with the Multipette Xstream.

In the case of usage options and user information applicable to both the Multipette stream and Multipette Xstream only the name Multipette stream or the name Multipette is given.

Store this manual so that it is readily accessible to all users.

If this manual is lost, please request another one. The latest version of the manual in this and other languages can be found on our website www.eppendorf.com

This operating manual applies to software version

Main: 01.08.00 Motor: 01.10.25 and higher

The software version is shown in the display when the battery is connected (see section 4.3) or when the device parameters are called up (see section 5.4).

If the Multipette stream is passed on to third parties, this operating manual must be included as well.

1.2 Meaning of warnings

Depiction	Explanation
	Warning about the risk of possible bodily injury.
CAUTION	Reference to low risk or risk of damage to property.

Multipette® stream / Xstream – 1 User Instructions

1.3 Glossary

Adapter plus	The Adapter plus ensures reliable guidance of the piston in the 50 ml or 25 ml Combitip plus cylinder. Two different Adapter plus are available. a blue Adapter plus for the 25 ml Combitip plus and a gray adapter for the 50 ml Combitip plus. A picture of the adapter can be found in section 4.3 on page 63.
ASA	Abbreviation for plastics made of acrylonitrile/styrene/acrylate.
Biopur	Eppendorf Biopur® is a quality and purity standard of Eppendorf AG for disposables. Besides the requirements for uniform quality such as precision, accuracy, wetting behavior or sealing, Biopur products fulfill the following requirements: – sterility – free of ATP, human and bacterial DNA, pyrogens and RNases. With Biopur products examination and certification is performed by an external laboratory. Lot-specific Biopur certificates www.eppendorf.com are available for download at our website.
Combitip plus	Dispensing unit based on the positive displacement principle for all Eppendorf Multipettes. With the Combitip plus the Multipette stream becomes a serviceable dispensing device. The Combitip plus consists of a piston and a cylinder. The Combitips plus are available for nine different volume ranges. A picture of all Combitips can be found in section 4.3 on page 62.
Increment	Increment stands for the step size or resolution. For example, with volume selection using a 10 ml Combitip plus the volume can be increased or reduced in 0.01 ml steps.
ISO 8655	The abbreviation ISO stands for "International Standardization Organization". The ISO 8655 standard makes specifications including limiting values (systematic error [accuracy] and random error [precision]) as well as the testing procedures for dispensing devices.
IvD Directive	"DIRECTIVE 98/ 79/EC OF THE EUROPEAN PARLIAMENT AND THE COUNCIL" dated October 27, 1998 relating to In-vitro-diagnostics.
LCP	Abbreviation for plastics made of liquid-crystal polymers.

Multipette® stream / Xstream – 1 User Instructions

Li-ion battery	Lithium-ion battery. Li-ion batteries have a very high charging capacity, resulting in a long battery life.
Multipette stream	Electronic dispensing devices described in this manual with the three modes Dis = dispensing (multi-dispensing); dispensing in several stages of equal size Pip = pipetting; dispensing in one stage Ads = automatic dispensing with actuate key held down
Multipette Xstream	As for the Multipette stream, but with the three additional modes Asp = aspirate for a defined take-up of liquid. A selected volume can be taken up in the Combitip plus several times consecutively. Seq = sequential dispensing. Dispensing in stages with different volumes. Ttr = titration. With the Multipette Xstream dispensing while holding down the actuate key. The volume dispensed is displayed.
Nominal volume	The maximum filling volume of a Combitip is the nominal volume. The term nominal volume has been agreed in the international ISO 8655 standard applicable to dispensing devices.
PhysioCare Concept®	The Eppendorf PhysioCare Concept is based on objectively measurable ergonomic criteria, as well as on considerations for which relevance can be determined by each user according to his conceptions. Further information see website www.physiocare-concept.info
PC	Abbreviation for plastics made of polycarbonate.
PE	Abbreviation for plastics made of polyethylene.
Positive displacement principle	With dispensing devices (such as those described here) this term stands for the direct aspiration and direct dispensing of liquid using a piston. With positive displacement the liquid is in contact with the piston. Only a little air bubble is visible at the piston in the Combitip. Unlike with an Eppendorf pipette, the liquid and piston are not separated by an air cushion (air displacer or air-cushion pipette).

Multipette® stream / Xstream – 1 User Instructions

PP	Abbreviation for plastics made of polypropylene.
Reverse Stroke	After aspiration of liquid, a downward movement of the piston in the Combitip plus to reach a defined position for the subsequent dispensing steps. The reverse stroke is indicated by "Discard next step" in the display and is started by pressing on the actuate key. The reverse stroke is not a dispensing step!

Multipette® stream / Xstream – 2 Product Description

2.1 Front view Multipette® Xstream

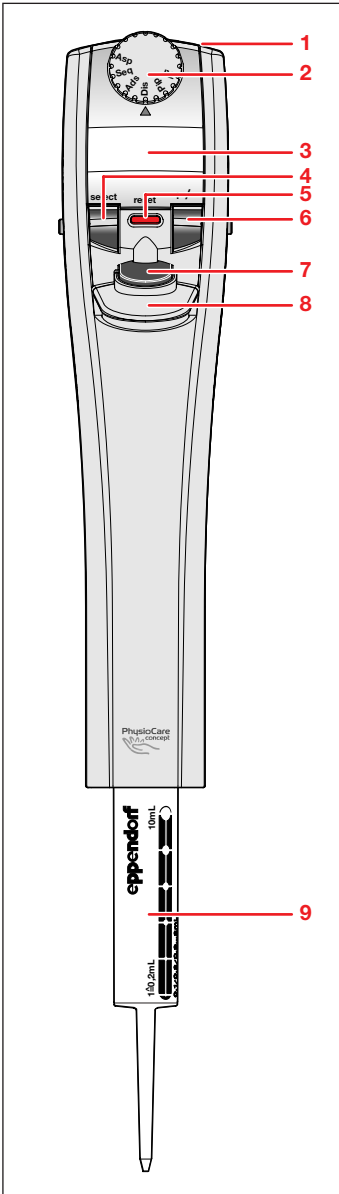

- 1 **Connector socket** for charging plug of power supply device
- 2 **Selection dial Multipette Xstream**
the mode **Dis** is selected
The desired mode is set by turning the selection dial.
The mode may not be changed during execution.
The three modes of the Multipette stream are:
Pip = pipetting
Dis = dispensing
Ads = automatic dispensing
In addition for the Multipette Xstream:
Asp = aspirate
Seq = sequential dispensing
Ttr = titrating
- 3 **Display**
- 4 **select rocker switch**
Use the select rocker switch to alternate between the execution display and the editing displays.
- 5 **red reset button**
The red reset button has several functions.
The most important functions are:
– Emergency brake to stop dispensing
– Piston in Combitip plus is moved down to home position
- 6 **+/- rocker switch**
The +/- rocker switch changes the relevant setting in editing displays.
- 7 **Actuate key**
for moving the piston in the Combitip;
while editing, also for returning quickly to the execution display.
- 8 **Ejector for Combitip plus**
CAUTION
Combitips may only be released when the piston is at the very bottom in the Combitip.
- 9 **Combitip plus** (here size 10 ml)
Insert Combitips plus from below pushing very firmly.

Multipette® stream / Xstream – 2 Product Description

2.2 Side view Multipette® Xstream

2

Product Description

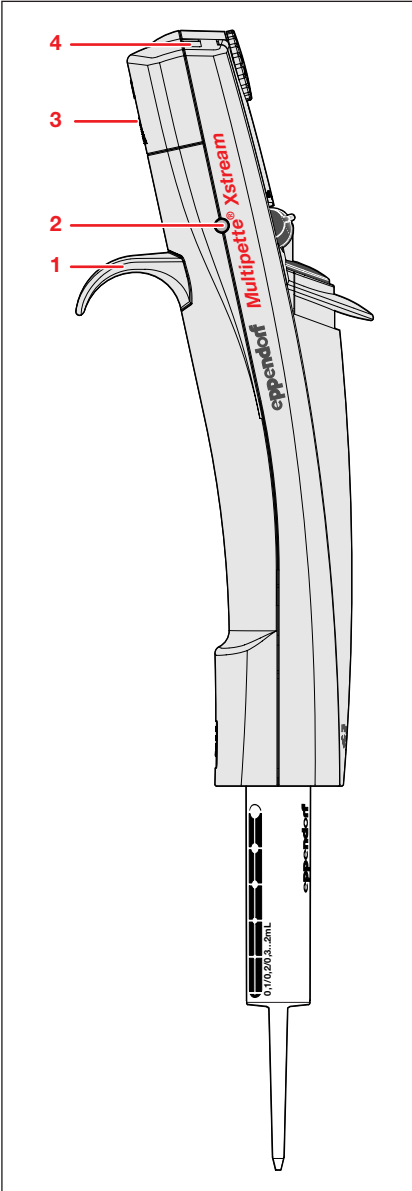

- 1 Finger rest**
- 2 Charging contact,**
with use of charging stand
(a charging contact can be found on both the
left and right-hand side)
- 3 Battery compartment lid,**
the Li-ion battery can be fitted or replaced
after removing the battery compartment lid.
When the battery compartment cover is
removed, the serial number can be seen in
the battery compartment of the Multipette.
- 4 Viewing window infrared interface**
(for Service)

Multipette® stream / Xstream – 2 Product Description

2.3 Delivery package

The delivery package includes the following parts:

	Order Number
– Multipette stream or Multipette Xstream	4986 000.017 4986 000.025
– 1 Adapter plus 25 ml	0030 069.528
– 1 Adapter plus 50 ml	0030 069.161
– 1 Combitip 5 ml for function test	0030 069.250 (order no. for 1 set)
– 1 Li-ion rechargeable battery	4986 602.009
– 1 power supply device with selectable power plug adapters	4986 601.002
– 1 operating manual	4986 900.018
– 1 Short Instructions	4986 900.034

Multipette® stream / Xstream – 2 Product Description

2.4 Product Properties

2.4.1 Application area

The Multipette stream and the Multipette Xstream are each equipped with a direct current motor plus incremental encoder and in combination with a Combitip plus, become electronically-controlled manual dispensers.

Power is supplied by a rechargeable Li-ion battery.

Using Combitips plus, the Multipette functions as a dispenser on the positive displacement principle.

They can be used by trained technical personnel in training, routine and research laboratory work in the biosciences, industry, hospitals and the field of chemistry. In-vivo applications (applications in or on the human body) are not permitted.

2.4.2 Dispensing tasks

It is possible to dispense aqueous solutions, but also solutions with a higher viscosity. At a higher viscosity, lower aspiration and dispensing speeds should be selected. If the lowest speed (1 bar) is used for aspiration and dispensing, it is possible to dispense solutions with a viscosity of up to 400 mPa · s in **Pip** mode.

CAUTION When using larger Combitips plus and highly viscous solutions, the Multipette may heat up. Highly viscous solutions can only be used for relatively short dispensing series.

In the case of solutions with a relatively high vapor pressure, it is advisable to saturate the little air bubble at the piston of the Combitip plus with liquid vapor by aspirating and dispensing the liquid several times.

CAUTION Solutions with a relatively high vapor pressure may not be an explosion risk.

CAUTION In the case of non-aqueous solutions, check the resistance to chemicals of the Combitip and of the Multipette stream (for materials, see section 2.4.3).

2.4.3 Materials

When performing dispensing tasks only use liquids that will not damage the materials of the Multipette and Combitip plus.

With the Combitip plus the cylinder is made of polypropylene (PP) and the piston of polyethylene (PE).

The pistons of sizes 0.1 ml and 0.2 ml are made of LCP.

The following materials are used for the Multipette stream:

- All light-gray housing parts and actuate key: acrylonitrile/styrene/acrylester(ASA) with polycarbonate (PC)
- Display area, selection dial, window IR interface: PC and painted PC
- Side charging contacts: gold plating
- Rocker switches and red reset button: silicone

Multipette® stream / Xstream – 2 Product Description

2.4.4 Eppendorf accessories

With the Multipette only Combitips plus and other original Eppendorf accessories should be used.

Use only the provided power supply device for charging.

2.4.5 Guarantee and warranty

In the case of warranty claims please contact your responsible Eppendorf contractual partner. The Li-ion battery is excluded from the warranty. When returning the Multipette to the Eppendorf contractual partner the necessary data for utilization and the performance of decontamination (see section 7.3 on page 85) should be included.

All maintenance and servicing must be carried out by the Service of the Eppendorf contractual partner.

No warranty shall apply with misuse or opening of the device by unauthorized persons.

Multipette® stream / Xstream – 3 Safety

3 General Safety Information

Please first read this operating manual and take the following general safety information into account before using the Multipette.

The Multipette is a lab device. It should only be operated by suitably qualified laboratory staff! All safety information included in the operating manual must be observed!

Handling

- The Multipette should only be used with Combitips plus!
- When using 25 ml Combitips plus or 50 ml Combitips plus fit a flawless Adapter plus to the Combitip.
- The assembly of adapter and 25 mL or 50 mL Combitip must always be performed outside of the Multipette!
- Combitips plus are designed for disposable usage!
Prolonged usage of one Combitip may have an adverse effect on the dispensing tasks.
- With Combitips never replace the piston or cylinder with a corresponding part from another lot.



Always dispense liquid into a vessel!

For dispensing liquids high dispensing speeds are selectable!

During dispensing watch out for liquid splashing and if necessary, reduce the dispensing speed.

Never point the Multipette at people!

CAUTION If the Combitip is inserted when a Multipette is put down, a stable setdown position must be selected.

A stable side position or the use of a charging stand is advisable.

CAUTION The Multipette stream should never be stored with a 25 ml, 50 ml Adapter plus or Combitip plus inserted for very lengthy periods.

CAUTION When setting down the Multipette, select a location that prevents contamination of the Multipette or contact with chemicals.

CAUTION If dispensing continues after a prolonged waiting period with a Combitip already filled, the next dispensing step may have a slightly reduced dispensing volume due to evaporation!

If dispensing requirements are stringent, discard this dispensing step.

CAUTION Never carry the Multipette stream holding the Combitip!



Red reset button

If the red reset button is held down or pressed briefly, a reset routine will take place with a motor- movement. When the Combitip is inserted, it should be ensured before initiating reset that the liquid contained in the Combitip can be dispensed without risk.



Emergency brake:

The reset button can during dispensing also be used as an emergency brake. Pressing briefly on the red reset button will stop the piston movement!

Multipette® stream / Xstream – 3 Safety

- Whenever using infectious, radioactive, toxic and other solutions harmful to health, the relevant safety regulations of your country must be observed. It is always necessary to comply with the relevant safety data sheet for a solution.
- Do not use the Multipette stream in environments at risk from explosion or with explosive chemicals.
- Before using organic solvents or aggressive chemicals, check the compatibility with the materials used in the Multipette stream and Combitip plus. Here the information about the materials given in section 2.4.3 on page 56 should be taken into account.
In addition, the Multipette stream should not be exposed to aggressive vapors on a lasting basis.
- The Multipette stream should only be operated at a temperature between +5 and +40 °C with an humidity of max. 92 %.

Care and maintenance

CAUTION The display, the selection dial and the labeling should not be cleaned with acetone or aggressive chemicals!

CAUTION Do not permit liquid to enter the Multipette stream!

- Soiling at the Combitip aspiration area should only be removed with a cotton tip.
- Repairs should only be performed by authorized Service.
- Use only original spare parts and original consumables (Combitips, Li-ion-battery).

Power supply and rechargeable battery

- The power plug of the power supply device should only be connected to voltage sources that correspond to the type data on the identification plate of the power supply device. In the event of any doubt which plug adapter should be used for the power supply device, you should ask an electrician for advice.
- For charging please only use the Li-ion battery forming part of the standard accessories and only the power supply device included in the delivery package.
- Before the first startup the battery must be charged in the Multipette stream.
- Never charge or use the Multipette stream without the battery.



Dispose of spent batteries according to the legal regulations.
Do not dispose of batteries together with domestic waste.



Passing on and disposal

When disposing of the Multipette stream this must take place according to the legal regulations.

Here please take note of the relevant remarks included in section 7.3 on page 85 and section 10.2 on page 89.

Multipette® stream / Xstream – 4 Startup

4.1 Power supply assembly

4

Startup

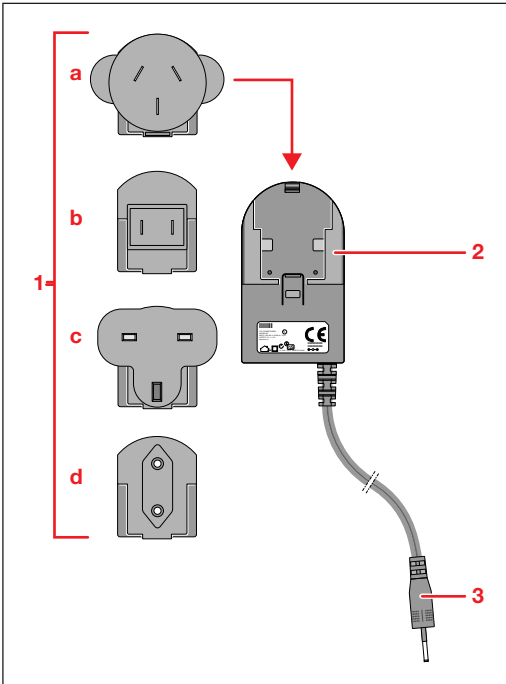

- 1** Power plug adapters
from top to bottom:
a Australia
b USA
c United Kingdom
d EU standard plug
- 2** Power supply
- 3** Charging plug
for Multipette stream

Fit the power plug adapter required for your power supply into the power supply device from above. The power supply device is designed for the range from 100 – 240 V.
To ensure that the Multipette stream is always charged with the right power supply device, the power supply device is provided with an adhesive label stating the name:

Multipette stream/Xstream

Repeater stream/Xstream.

Multipette® stream / Xstream – 4 Startup

4.2 Insertion and charging of Li-ion battery

CAUTION

Before the first startup the battery must be charged in the Multipette stream!

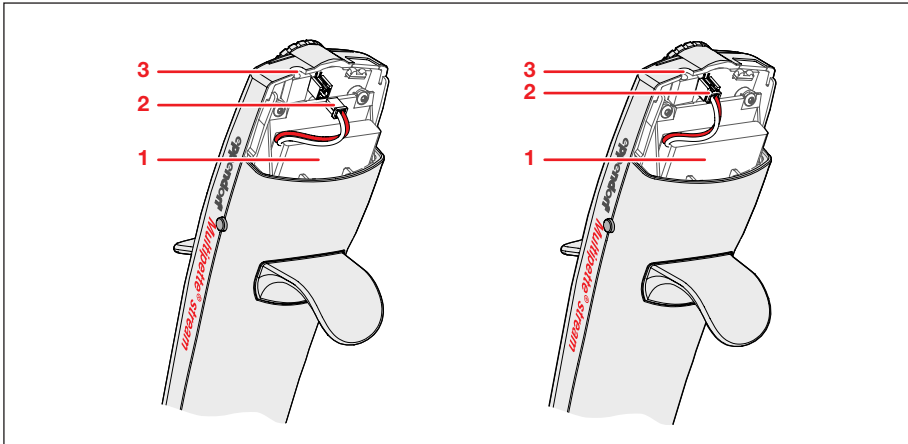

- 1 Li-ion battery**
- 2 Plug**
The red cable should always be on the right with insertion
- 3 Connector socket**
for charging plug of power supply device

Execution

1. Take the lid off the battery compartment and insert the Li-ion battery from the accessories.
CAUTION
The foam insert in the battery compartment may not be removed!
2. Connect the plug of the Li-ion battery to the Multipette (the red cable should always be on the right).
3. Replace the battery compartment lid and charge the Multipette.
Use only the power supply device provided for charging.
4. To do so, plug the assembled power supply device (see section 4.2) into an appropriate power outlet and the charging plug of the power supply device into the connector socket of the Multipette stream.

 Alternatively, the charging stand described in section 4.3 can be used for charging. The Multipette stream can be operated sometimes with the power supply device during charging of the battery.

A fully-discharged Li-ion battery takes approx. 2 hours to charge.

Multipette® stream / Xstream – 4 Startup

4.3 Accessories

Overview Combitips plus

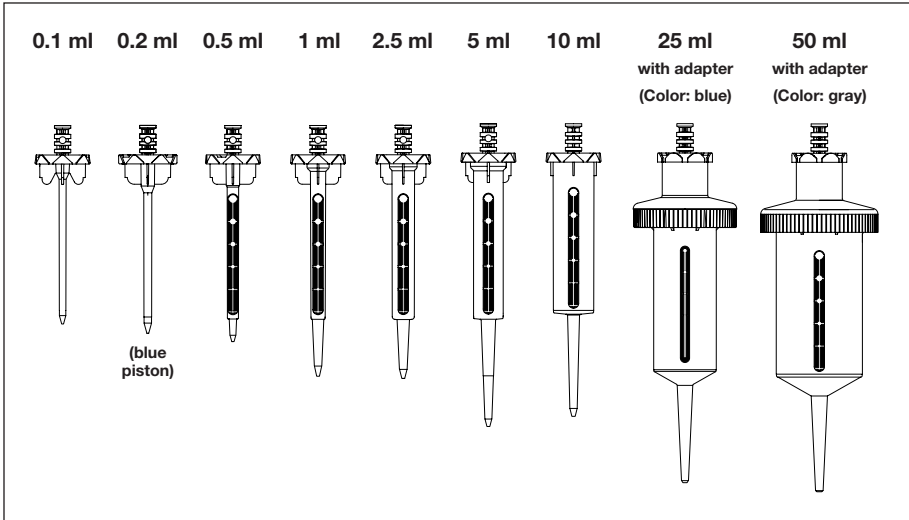

Table of volume ranges for Combitips plus with Multipette stream

Combitip plus	Smallest volume	Largest volume	Increment
0.1 ml	1.0 µl	100.0 µl	0.1 µl
0.2 ml	2.0 µl	200.0 µl	0.2 µl
0.5 ml	5.0 µl	500.0 µl	0.5 µl
1.0 ml	10 µl	1000 µl	1 µl
2.5 ml	25 µl	2500 µl	2.5 µl
5.0 ml	50 µl	5000 µl	5 µl
10.0 ml	0.10 ml	10.00 ml	0.01 ml
25.0 ml	0.25 ml	25.00 ml	0.025 ml
50.0 ml	0.50 ml	50.00 ml	0.05 ml

When the smallest volume is selected, 100 dispensing steps will result with every Combitip plus and Multipette stream.

The Combitips plus and Adapter plus are available in standard quality and as Eppendorf-Biopur® quality.

Multipette® stream / Xstream – 4 Startup

Assembly of Combitip plus with Adapter plus

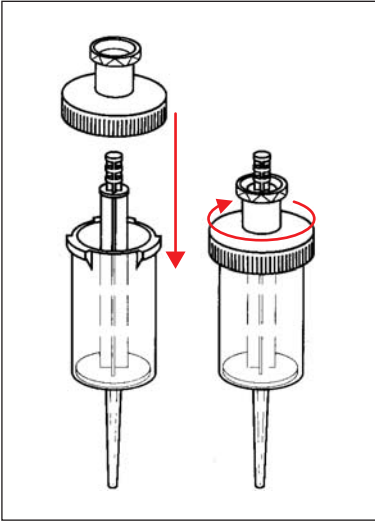

CAUTION With 25 ml and 50 ml Combitips assembly of the Combitip and adapter always takes place outside the Multipette!

Installation of Combitip plus

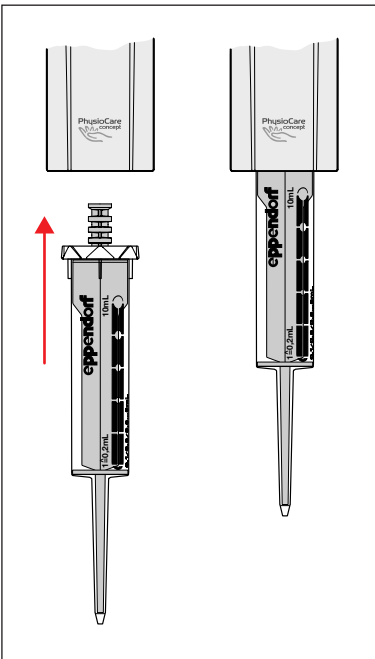

When inserting the Combitip plus in the Multipette, the piston is right at the bottom in the Combitip cylinder.

Insert the Combitip plus into the Multipette from below pushing very firmly.

 It is easier to insert the Combitip with the ejector pressed down. The Combitip must then be kept pressed until the ejector is released.

Multipette® stream / Xstream – 4 Startup

Charging stand

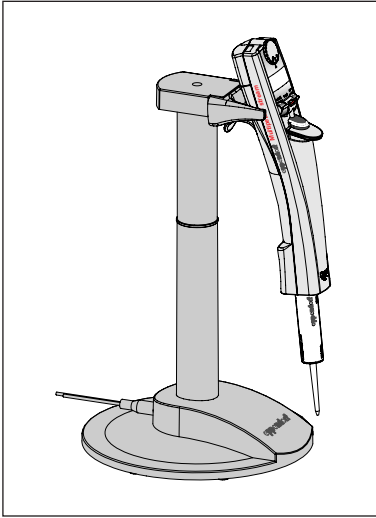

The charging stand shown here can be used for storage and simultaneous charging of the Multipette battery.

The charging plug for the Multipette stream is connected to the charging stand.

In the charging stand the Multipette stream is charged and held in position by the side gold charging contacts.

Combilong

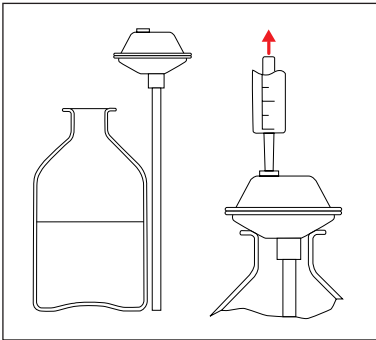

The Combilong is an aspirating aid for the Multipette.

Using the Combilong, liquids can be directly taken out of all bottles.

Combitip rack

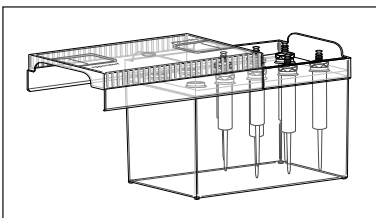

A rack is available for storing Combitips plus. It is specially recommended for sterile Biopur Combitips.

The Combitip rack can be autoclaved.

 Combitips plus are not autoclavable!

Multipette® stream / Xstream – 5 Operation

5.1 Overview of operator control elements

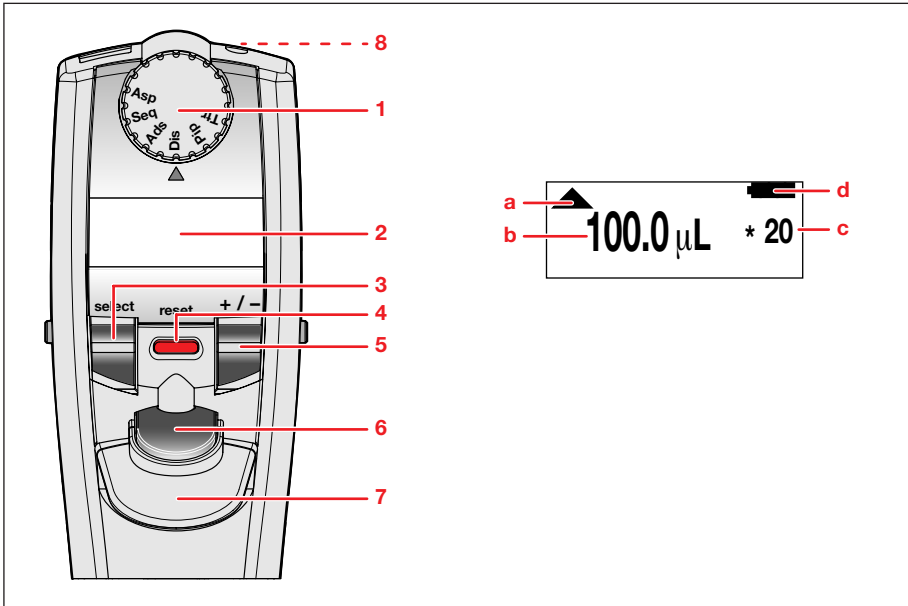

1 Selection dial Multipette Xstream

The picture shows "Dis" as the mode selected.

Only the modes "Asp", "Seq" and "Ttr" are available with the Multipette Xstream. The mode selected should not be changed during execution.

2 Display

After the Combitip is inserted, the last data stored for this Combitip are loaded following a brief display of Combitip size and selected mode.

In Dis mode, the information shown top right will be displayed in the Start display:

a = display of direction,
here for aspiration of liquid

c = number of dispensing steps

b = volume for a dispensing step;
volume unit in µL or mL

d = battery charge level;
display shows fully charged battery here

The information in the Start display for the other modes is similar.

More displays can be accessed using the select rocker switch.



If the Multipette stream is not used, the display is switched off after approx. 5 minutes. It is switched back on by pressing actuate key, select or +/- rocker switch long.

Multipette® stream / Xstream – 5 Operation

3 select rocker switch

The select rocker switch is used to switch from the relevant execution display to displays which can be edited.

4 red reset button

The red reset button has several functions:

- Pressing with piston in motion:
emergency brake to stop accidental dispensing of liquids!
- Pressing with piston not in motion:
dispensing of liquids! The piston is moved to the home position!
- Press briefly:
Acknowledgement of error message
- Held down: Motor checks all dispensing paths!
With filled Combitip plus: dispensing of liquids!

5 +/- rocker switch

The +/- rocker switch changes the relevant setting in editing displays.

- The +/- rocker has two setting levels for adjusting the volume.
Level 1 (Rocker slightly pressed): Slow change (Step size corresponds to the increment of the Combitip; see overview of Combitips plus in Ch. 4.3 Accessories).
Level 2 (Rocker strongly pressed): Quick volume change.
- Many settings, for example speeds, can be amended during execution.

6 Actuate key

If the actuate key is pressed, the piston in the Combitip is moved according to the direction shown in the display.

If you have used the select rocker switch to reach an editing display, you can quickly return to the last execution display by pressing the actuate key. The next time the actuate key is pressed, execution continues.

7 Ejector for Combitip plus; Combitips plus may only be released when the piston is at the very bottom in the Combitip!

If editing is ended by ejection of the Combitip, the changes executed previously will not be saved.

8 Connector socket for charging plug of power supply.

During charging the battery symbol flashes in the display.
The battery charge level is shown permanently in the display.
Black segments indicate the presence of power capacity.

Acoustic signals

Certain signals assist the user for different operations.

The acoustic signals (Beep) are a help when you are familiarizing yourself with the operating procedure. They can also be switched off if required (see Sec. 5.4).

Multipette® stream / Xstream – 5 Operation

5.2 Application examples

-  Many of the options described for "Dis" mode also apply to the other modes. For this reason you should use the "Dis" mode described here together with the Multipette stream in order to learn overall operation. The Multipette stream should not have been changed from the factory "System settings" (see section 5.4).

5.2.1 "Dis" Dispensing mode

During dispensing the aspirated liquid is dispensed step by step in partial volumes of equal size. With the smallest dispensing volume of a Combitip plus 100 dispensing steps result with a completely filled Combitip plus.

In the laboratory dispensing is also known as "multi-dispensing".

Volumes greater than 5 µl (0.5 ml Combitip) can be dispensed in free jet (Condition: maximum dispensing speed is selected).

5.2.1.1 Editing of "Dis" mode

1. Select "Dis" mode using the selection dial.
2. Select a suitable Combitip for the dispensing task.

Information:

- All available Combitip sizes can be found in section 4; page 62.
- Insert the Combitip or Combitip with adapter as described in section 4.3 page 63. After attaching a Combitip, the last data saved for this Combitip size will be loaded. The volume for a dispensing step and the number of dispensing steps are shown in the display.

When a 5 ml Combitip plus is used for the first time, this appears:



This display starts execution.

Multipette® stream / Xstream – 5 Operation

- Press the **select rocker switch** up or down.
The Start display (for execution) is exited.

Individual displays for editing will then be shown:

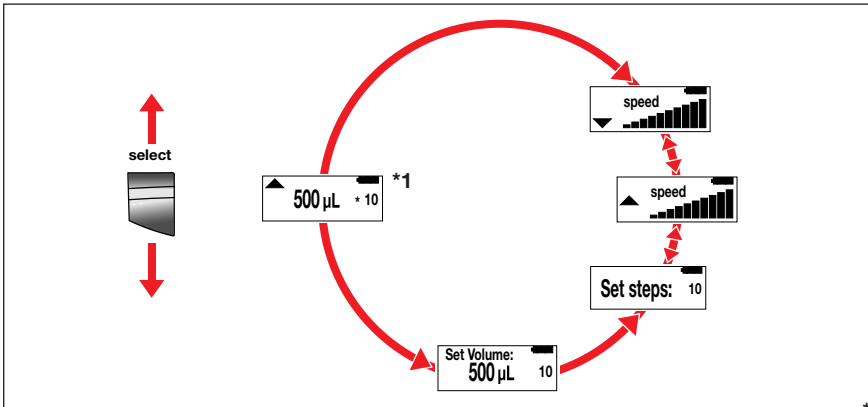

- If the select rocker switch is pressed during execution, the current execution display will be shown at this point.

- Press the **+/- rocker switch** up or down.

The **+/- rocker switch** can be used to amend a setting in the displays shown above on the right side.

If the +/- is pressed more strongly, the volume change takes place in larger steps.

When the volume is selected, the associated maximum number of steps is automatically adjusted:

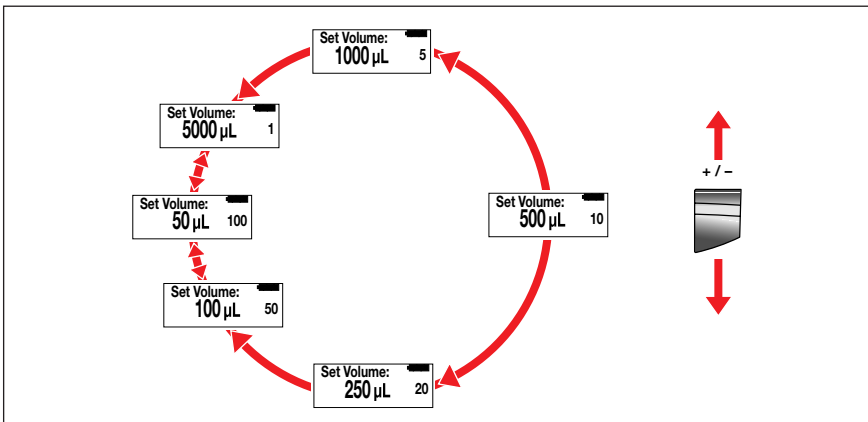

- The volume can also be amended during execution between the dispensing steps. The same also applies to the following displays.

Multipette® stream / Xstream – 5 Operation

If necessary, you can use the +/- rocker switch to reduce the number of dispensing steps in the display on the right. Amendments are also possible during execution.



If necessary, you can use the +/- rocker switch to amend the aspiration speed and dispensing speed in the display on the right.



Amendments are also possible during execution.



With every Combitip plus 10 speed levels are available in each mode.

The total number of bars filled in black stand for the speed level selected. In the above displays the highest speed is always selected. High speeds use less power than low speeds.

For dispensing small volumes in free jet, maximum speed should always be used.

If there is a risk of liquid splashing out of the target vessel during dispensing, the speed of dispensing must be reduced.

Very slow speeds are recommended for viscous solutions.

5. After editing, return to the starting display using the select rocker switch or the actuate key. Pressing the actuate key will save your entries.

 It is possible to store individual parameters like speeds, steps and volume for each Combitip size in every mode.

If the solution is to be mixed prior to dispensing, the special speeds for mixing can be saved in the "Pip" mode (see Ch. 5.2.2.1).

Multipette® stream / Xstream – 5 Operation

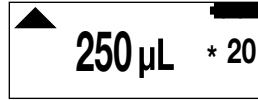

5.2.1.2 Execution of "Dis" mode

1. The display shows the selected volume for a dispensing step and the selected dispensing steps:



If you are performing the following steps for the first time, you should only perform them with water for safety reasons.

In addition, do not fail to bear in mind the different functions of the red reset button (see section 5.1; page 66).

2. Immerse the lower part of the Combitip plus in the liquid to be aspirated.
 - Press the actuate key .
 - The piston in the Combitip plus moves up. Liquid is aspirated.
 - If you press the actuate key  (or red reset button) again during aspiration, aspiration will end as this key is pressed.
Hint: In this case the resulting steps will not be stored for the next execution.
3. After aspirating liquid the display shows:



The following step is the reverse stroke. The reverse stroke is not a dispensing step!

Decide whether the liquid of the reverse stroke is to be dispensed

into the supply vessel

or

into a waste container!

- Then press the actuate key  to initiate the reverse stroke.
4. The dispensing steps follow next.

Every dispensing step is initiated by pressing the actuate key  :

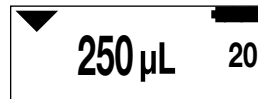

Here the display always shows the remaining dispensing steps.

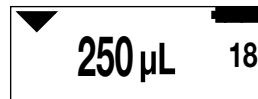
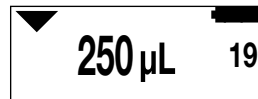

Multipette® stream / Xstream – 5 Operation

5. After the dispensing steps the following display appears:

long = aspirate ▲
 1.short = no step
 2.short = empty ▼

The piston in the Combitip is not yet in its lowest position.

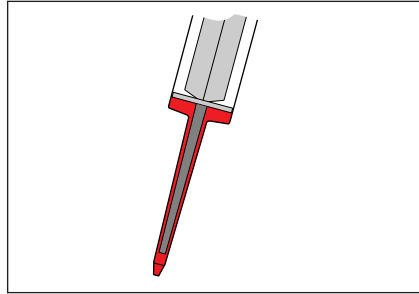

6. There are two possible variants for continuing execution.

Variant 1: Renewed aspiration

- Immerse the Combitip in the liquid to be aspirated again.
- Hold down the actuate key .
- The renewed aspiration of liquid will start.
- The piston in the Combitip moves up.
- Follow the further procedure as described under item 3

Variant 2: Empty Combitip

- Press the actuate key  once briefly.
- No piston movement.
 A beep tone indicates that the next step is not a dispensing step.
 The following display appears:

long = aspirate ▲
 short = empty ▼

Note:

It is also possible to continue dispensing with variant 1 at this point.

- Hold the Combitip over a suitable vessel to dispense the residual liquid.
- Briefly press the actuate key  again.
- The piston dispenses residual liquid and moves to the lowest position (home position).
- After this you can release the Combitip plus by actuating the ejector!

Multipette® stream / Xstream – 5 Operation

5

Operation

With lengthy pauses between the dispensing steps:

The display can be switched back on by pressing the actuate key or the rocker switches long. With very long pauses evaporation is possible with certain liquids. You should therefore check whether the next dispensing step must be discarded. If very long dispensing pauses result in crystallization in the Combipip plus, a new Combipip must be used. Empty the Combipip inserted by pressing the red reset button.

If the battery capacity is too low, execution is cancelled with an error message.

Dispensing can be continued once the power supply device has been connected. The Li-ion battery is charged at the same time.

5.2.2 "Pip" Pipetting mode

If you only wish to dispense a volume once, use of "Pip" mode is recommended.

If pipetting tasks are required in addition to dispensing tasks, these volumes and speeds can also be stored in this mode for each Combipip size.

The "Pip" mode can also be used to mix a solution.

If a solution must be dispensed at low speed in the "Dis" mode, but quickly mixed before, this can be accomplished by combining these two modes!

5.2.2.1 Editing "Pip" mode

Select "Pip" mode using the selection dial.

Select a Combipip that can aspirate the required dispensing volume.

Editing is comparable with "Dis" mode. The same displays as in section 5.2.1 are available for editing with the exception of "Number dispensing steps".

5.2.2.2 Executing "Pip" mode

Execution is identical with "Dis" mode and the setting "1 dispensing step":

1. Aspiration of liquid
Hint: If you press the actuate key or the red reset button during aspiration, aspiration will be stopped. The volume resulting for dispensing in this case is not stored for the next time the operation is performed.
2. Reverse stroke (no dispensing volume!)
3. Pipetting step
4. After the pipetting step you can select between
 - the renewed aspiration of liquid (hold down actuate key)
 - complete emptying (press the actuate key twice in succession) and afterwards release of Combipip plus. Or the choice of another mode.

Multipette® stream / Xstream – 5 Operation

5.2.3 "Ads" Automatic Dispensing mode

In "Ads" mode the actuate key is held down when dispensing the dispensing volumes. So that it is not necessary to keep pressing the actuate key for repeated dispensing of the dispensing volume, the use of "Ads" mode instead of "Dis" is helpful, particularly for lengthy dispensing series (filling plates).

5.2.3.1 Editing "Ads" mode

1. Select "Ads" mode using the selection dial.
2. Insert a suitable Combitip for the dispensing task.
3. The editing displays are accessed using the select rocker switch. Along with the already familiar displays of "Dis" mode, the delay time between dispensing steps can be viewed or amended in the display on the right side.

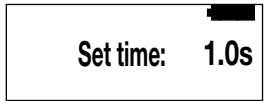

You can amend the delay time between dispensing steps from 0.1 to 10.0 seconds using the +/- rocker switch.

When filling plates with 96 wells, times between 0.6 and 2 seconds are advisable depending on the liquid.

4. After editing, return to the starting display using the select rocker switch or the actuate key. Pressing the actuate key will save your entries.

5.2.3.2 Execution of "Ads" mode

1. The display shows the selected volume for a dispensing step and the selected dispensing steps:

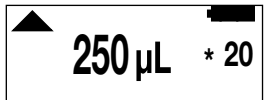

2. Immerse the lower part of the Combitip plus in the liquid to be aspirated.
3. Press the actuate key .

4. After aspirating liquid the display shows:



The following step is the reverse stroke. The reverse stroke is not a dispensing step!

- Release the "reverse stroke" by briefly pressing the actuate key .

Multipette® stream / Xstream – 5 Operation

5. The automatic dispensing steps follow next.

- For this hold the actuate key  down permanently:

The dispensing steps are executed with the delay time selected

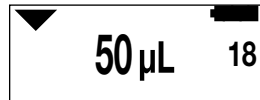

Here the display always shows the next dispensing step.

If the actuate key is released, the next dispensing steps will not be executed.

If the dispensing key is held down again, dispensing will be continued.

6. After the dispensing steps the following display appears:

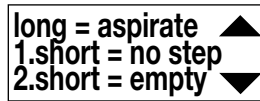

The piston in the Combipip is not yet in its lowest position.

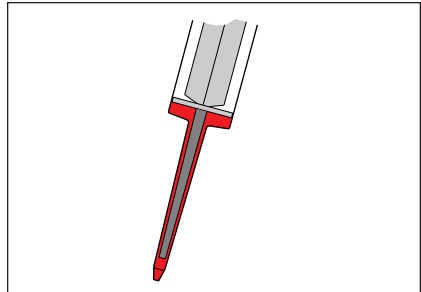

- Do not hold down the actuate key any longer.
- After the last dispensing step you can select between:
- renewed aspiration of liquid (hold down actuate key)
- complete emptying (press actuate key twice in succession) and afterwards release of Combipip plus.

Multipette® stream – 5 Operation

5.3 Example applications for the Multipette Xstream modes

5.3.1 "Asp" Aspirate mode with the Multipette Xstream

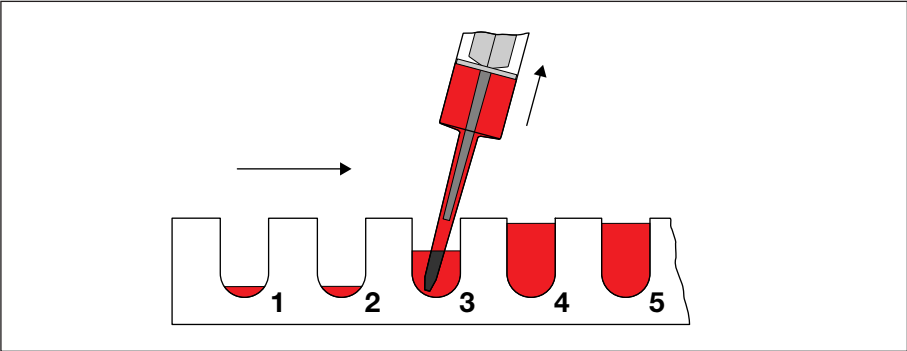

In "**Asp**" Aspirate mode, a defined volume can be aspirated into the Combipip several times in succession. For example, if a certain volume is to be removed from the wells of a plate, this is simple to execute in "**Asp**" mode. After removal of the part-quantities, the Combipip is emptied. "**Asp**" Aspirate mode proceeds roughly in reverse from Dispensing mode.

5.3.1.1 Editing "Asp" mode

1. Set the selection dial of the Multipette Xstream to "**Asp**" mode.
2. Attach the required Combipip plus.

In addition to aspiration volume, the number of aspiration steps, aspiration speed and dispensing speed can be defined.

3. In order to do this, first press the select rocker switch. The procedure is similar to "**Dis**" mode in section. 5.2.1.1 page 67.

It is advisable to use a slow aspirating speed if trying to avoid disturbing a sediment or trying to maintain a phase boundary.

4. After editing, return to the first display using the select rocker switch or by pressing the actuate key. The entries are stored by pressing the actuate key.

Multipette® Xstream – 5 Operation

5.3.1.2 Executing "Asp" mode

1. After attaching a Combipip, the last data saved for this Combipip size will be loaded.

The display then shows the volume of one aspiration and the number of aspiration steps:



2. Press the actuate key.
There will be no piston movement!
The display will then show:



The next step is not an aspiration step!
The piston of the Combipip will be moved to a defined position.

3. Press the actuate key. The display will then show:



4. By pressing the actuate key once again, the liquid will be aspirated.
To prevent accidental aspiration of air, it is advisable to immerse the Combipip in the liquid relatively deeply.

The display always shows the liquid aspirations which have already taken place:

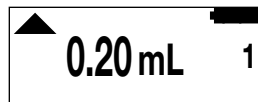

⋮



5. After the last aspiration a safety step takes place.
Press the actuate key.
No piston movement takes place.
This insures that the entire amount of liquid is not incorrectly dispensed by mistake.

The display shows:



Multipette® Xstream – 5 Operation

6. Pressing the actuate key again leads to the total amount of liquid being dispensed.
The piston is moved back into its starting position.
The Combitip can be released.
Alternatively you can start aspirating again as described in item 2 of this section.

-  If an undefined quantity of liquid is to be aspirated, this can be executed in Pip mode using a slow aspirating speed.
Aspiration is stopped when the actuate key is pressed again.
After the reverse stroke, the potential pipetting volume is displayed.
The volume aspirated is marginally larger than the pipetting volume.

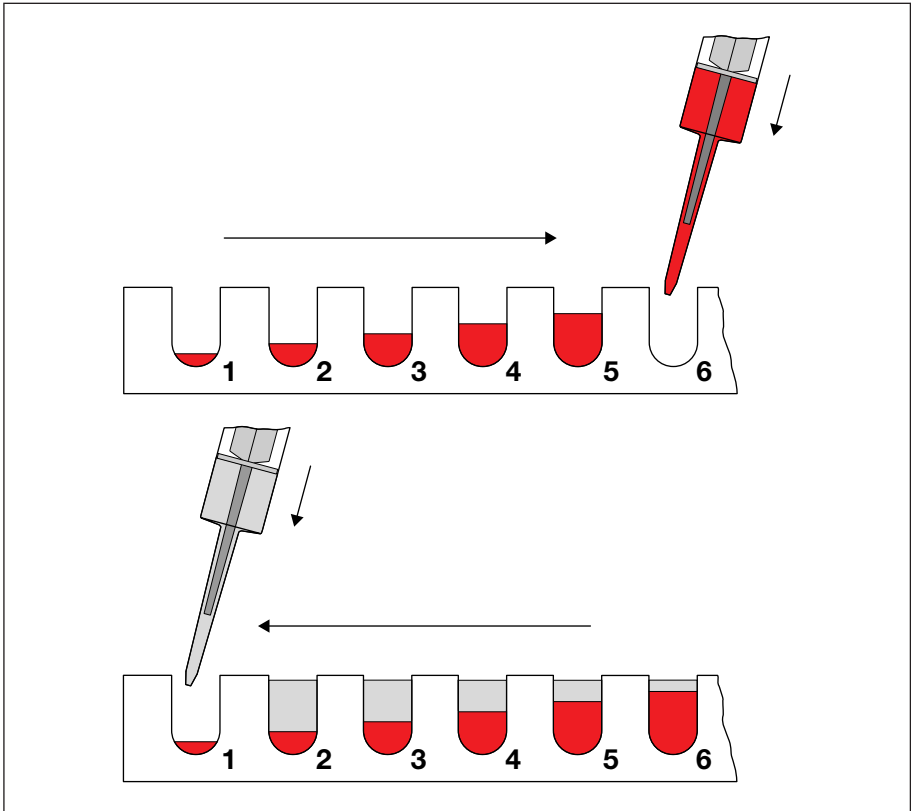
Multipette® Xstream – 5 Operation**5.3.2 "Seq" Sequential Dispensing mode**

In "**Seq**" mode, up to 16 different dispensing volumes can be defined.

If sequential dispensing as shown above is executed with the same volumes in opposite directions, it is possible to produce different dilutions for the same total volume.

Multipette® Xstream – 5 Operation

5.3.2.1 Editing "Seq" mode

When editing "Seq" mode, the following should be kept in mind:

- Number of dispensing steps and the different volumes to be dispensed can not be changed during execution.
- It is possible to change speed during execution. The dispensing speed applies to all dispensing volumes.
- The sum of dispensing volumes may not exceed the nominal volume of a Combitip plus.
- Volumes, speeds and steps can be defined to suit each individual Combitip size.

To edit "Seq" mode, proceed as follows:

1. Select "Seq" mode using the selection dial.
2. Attach the appropriate Combitip plus.
3. Briefly press the select rocker switch down once.
The display shows:



4. Specify the number of dispensing steps (max. 16) using the +/- rocker switch.

5. Briefly press down on the select rocker switch again.
The first dispensing step will appear in the display.
The number of the dispensing step is shown on the right-hand side of the display.



6. Specify the dispensing volume using the +/- rocker switch.
7. Repeat steps 5 and 6 for all the other dispensing steps.
It is also possible to scroll back by pressing up the select rocker switch.
It is possible to correct dispensing volumes using the +/- rocker switch.
8. Define aspiration and dispensing speeds using the select and +/- rocker switches.
9. Return to the starting display using the select rocker switch or by pressing the actuate key.
The entries are stored by pressing the actuate key.

-  By pressing the actuate key, you can always switch to the Start display for execution. This display then shows the sum of all selected dispensing volumes. This makes it easy to check during editing which volume of Combitip has already been used.
When the nominal volume is reached, further dispensing steps are shown with "n n n n" instead of a volume.

Multipette® Xstream – 5 Operation

5.3.2.2 Executing "Seq" mode

1. Select "**Seq**" mode using the selection dial .
2. Insert the desired Combitip.
3. The display shows the total volume and the number of dispensing steps:



4. The rest of execution is identical to "**Dis**" mode.
For a description of "Dis" mode execution, see section 5.2.1.2 on page 70.

If aspiration is stopped prematurely by the actuate key being pressed again, only the dispensing steps possible with the aspirated volume can be executed.
The display always shows the next dispensing step before dispensing.

5.3.3 "Ttr" Titration mode with the Multipette Xstream

In this mode, liquid dispensing takes place with the actuate key held down.
If the actuate key is released, the piston movement stops and the dispensed volume will be displayed.
When titration continues, dispensing speed is automatically reduced.

5.3.3.1 Editing "Ttr" mode

Aspiration and dispensing speed can be defined for "**Ttr**" mode, if required.
Automatic reduction of dispensing speed can be corrected during execution.
To change speed, proceed as follows:

1. Press the select rocker switch up or down.
2. The displays for aspiration or dispensing speed appear.
3. Select the desired speed using the +/- rocker switch.

Multipette® Xstream – 5 Operation

5.3.3.2 Executing "Ttr" mode

1. Select "Ttr" mode using the selection dial.
2. Insert the desired Combitip.
3. The display shows "0".
4. Press the actuate key to aspirate liquid.
5. If less liquid than the nominal volume must be aspirated: press the actuate key again to stop aspiration.
6. The display shows "Discard next step".
Press the actuate key briefly. The reverse stroke is executed.
The reverse stroke is not a dispensing step!
7. Hold down the actuate key.
The liquid dispensing for titration takes place.
When the actuate key is released, this stops movement of the piston and the dispensed volume is displayed.
8. Continuing titration:
 - Keep the actuate key pressed again.
 - Dispensing continues at reduced speed.
Speed is reduced one stage after each stop.
Correct speed, if required, using the select and +/- rocker switches.
 - After each stop the sum of dispensed volumes is displayed.
 - If the titration is complete with a Combitip still full, the remaining liquid is dispensed by pushing the red reset button.
 - After that, the titration volume is displayed until the Combitip is released.
9. If the actuate key is pressed briefly for both displays, the remaining liquid will be dispensed.
After that, the titration volume is displayed until the Combitip is released.
Totaling of those volumes also ends.

long = aspirate ▲

1.short = no step

2.short = empty ▼

long = aspirate ▲

short = empty ▼
10. If the Combitip volume is not sufficient for titration, the Combitip is refilled (hold down actuate key). The titration is continued by pressing the actuate key again.
11. Totaling of titration volumes will continue.
The volume from at least 10 fillings of a Combitip can be displayed.
An out-of-range reading is indicated by **n n n n**.

Multipette® stream / Xstream – 5 Operation

5.4 Device Parameters

Device parameters govern higher-order settings and information. The beeper can be switched on and off in the device parameters. The software version in the Multipette is also shown here.

To access the device parameters, proceed as follows:

1. There is no Combitip in the Multipette.
2. Press both rocker switches up for about 3 seconds.
3. "**Entry system settings**" will appear briefly in the display.
4. The individual parameters are accessed using the select rocker switch.
5. The respective setting is changed using the +/- rocker switch.





The device parameters can be exited by

- holding both rocker switches up simultaneously for an extended period
- or
- press the actuate key.
- or
- attaching a Combitip.

Changes of device parameters are stored immediately.

Multipette® stream / Xstream – 6 Troubleshooting

6.1 Troubleshooting table

Display information	Cause	Remedy
 One segment pale.	Battery discharged.	Complete dispensing operation and charge battery (see section 4.2).
 Two segments pale.	Battery severely discharged.	Finish dispensing operation immediately and charge battery (see section 4.2).
Warning Battery Low!	Battery severely discharged.	Confirm with actuate key. Charge battery immediately.
Charge or use with power supply	Battery empty.	Charge battery. Dispensing operations can be continued with the power supply device connected.
Battery empty connect charger	Battery empty.	Charge battery. Dispensing operations are not possible.
Wait Battery charging	Charging in progress.	
 All segments flashing.	Charging in progress.	Charge until the battery symbol is displayed in the vertical position.
 Segments dark and vertical.	Charging process complete.	Multipette is ready for use again.
 (Display dark)	<ul style="list-style-type: none"> – Multipette is in Sleep mode. – No battery in the Multipette. – Battery is completely discharged. (Battery also discharges when not in use.) – Battery defective. 	<ul style="list-style-type: none"> – Press actuate key long to switch on the Multipette. – Insert battery in the Multipette. – Charge the Multipette with its battery. – Insert new battery.
Reset! Piston stopped	Emergency brake: the red reset key was pressed briefly during dispensing.	
Press reset! Attention! Piston moves!		Ensure safe dispensing into a tube. Then press the red reset key again to empty the Combipip.
Reset: Piston movement	Red reset key pressed again briefly.	

Multipette® stream / Xstream – 6 Troubleshooting

Display information	Cause	Remedy
<div style="border: 1px solid black; padding: 5px; text-align: center;"> ERROR! Cylinder lost Press reset! </div>	Ejector inadvertently pressed during use, releasing the cylinder of the Combitip.	Do not continue using the Combitip! There may be a dispensing fault! Carefully draw the cylinder of the Combitip down a little.
<div style="border: 1px solid black; padding: 5px; text-align: center;"> Reset: Piston movement </div>	Red reset key pressed briefly.	Pressing the red reset key moves the piston of the Combitip downwards. CAUTION! Press the ejector again to release the piston from the Combitip attachment!
<div style="border: 1px solid black; padding: 5px; text-align: center;"> TIP: Insert Combitip </div>		
<div style="border: 1px solid black; padding: 5px; text-align: center;"> TIP: Insert Combitip </div>	No Combitip plus inserted.	Only insert a Combitip plus.

Other error messages appearing in the display are significant only for error diagnosis by Service.

If the error message cannot be eliminated by briefly pressing the red reset key or removing and reinserting the battery (see section 4.2), then inform Service.

Problem	Cause	Remedy
Filled Combitip should be emptied or removed.	Residual liquid present is no longer required. Or a different Combitip should be inserted.	CAUTION! Ensure dispensing into a tube and briefly press red reset key.
Combitip dripping.	Combitip leaking.	Change Combitip.
Battery has to be charged very frequently.	Charging capacity of battery has dropped or a great many dispensing operations are being performed regularly.	In the event of reduced charging capacity: Order a new Li-ion battery.

If there is doubt that dispensing data are correct

To avoid dispensing errors, the precision and accuracy of the Multipette stream need to be checked regularly.

A SOP (Standard Operating Procedure) for checking pipettes can be called up from our homepage www.eppendorf.com.

Multipette® stream / Xstream – 7 Maintenance

7.1 Cleaning

Care and maintenance

CAUTION The display, the selection dial and the labeling should not be cleaned with acetone or aggressive chemicals!
Note the material specifications (section 2.4.3; page 56) and the chemical resistance of the materials!

CAUTION Do not permit liquid to enter the Multipette stream!

- Only wipe the housing of the Multipette stream with a slightly damp or dry cloth.

CAUTION Corrosion caused by cleaning and disinfection agents.
Use neither corrosive cleaning agents nor aggressive solvents or scouring agents.

- Soiling at the Combitip aspiration area should only be removed with a cotton tip.
- Repairs should only be performed by authorized Service.
- Use only original spare parts and original consumables (Combitips, Li-ion-battery).

7.2 Disinfection / Decontamination

Alcohol-based disinfectants are permitted.

No liquid may penetrate the Multipette stream, so do not spray the Multipette, but wipe it down carefully with disinfectant. Then dry using another cloth.

7.3 Decontamination before dispatch

If you wish to send the Multipette stream to the Technical Service department, please note the following:



Health risk from contaminated device.

- ▶ Perform decontamination before dispatching or storing the device or its accessories.

1. Follow the instructions on the decontamination certificate.
This can be found in the form of PDF file on our homepage, www.ependorf.com
2. Decontaminate all parts you want to dispatch.
3. Enclose the fully-completed decontamination certificate for returned goods (incl. the serial number of the device) with the dispatch.

Multipette® stream / Xstream – 8 Technical Data

8.1 Technical Data

Combitip plus	Dispensing range (min./max.)	Increment	Test volumes	Systematic error (Bias; Inaccuracy) [%]	Random error (Imprecision; CV) [%]
0.1 mL	1–100 µl	0.1 µl	10 µl	±1.6	≤ 2.5
			50 µl	±1.0	≤ 1.5
			100 µl	±1.0	≤ 0.5
0.2 mL	2–200 µl	0.2 µl	20 µl	±1.3	≤ 1.5
			100 µl	±1.0	≤ 1.0
			200 µl	±1.0	≤ 0.5
0.5 mL	5–500 µl	0.5 µl	50 µl	±0.9	≤ 0.8
			250 µl	±0.9	≤ 0.5
			500 µl	±0.9	≤ 0.3
1.0 mL	10–1000 µl	1.0 µl	100 µl	±0.9	≤ 0.55
			500 µl	±0.6	≤ 0.3
			1000 µl	±0.6	≤ 0.2
2.5 mL	25–2500 µl	2.5 µl	250 µl	±0.8	≤ 0.45
			1250 µl	±0.5	≤ 0.3
			2500 µl	±0.5	≤ 0.15
5 mL	50–5000 µl	5 µl	500 µl	±0.8	≤ 0.35
			2500 µl	±0.5	≤ 0.25
			5000 µl	±0.5	≤ 0.15
10 mL	0.10–10.00 ml	0.01 ml	1.00 ml	±0.5	≤ 0.25
			5.00 ml	±0.4	≤ 0.25
			10.00 ml	±0.4	≤ 0.15
25 mL	0.25–25.00 ml	0.025 ml	2.50 ml	±0.3	≤ 0.25
			12.50 ml	±0.3	≤ 0.25
			25.00 ml	±0.3	≤ 0.15
50 mL	0.50–50.00 ml	0.05 ml	5.00 ml	±0.3	≤ 0.25
			25.00 ml	±0.3	≤ 0.2
			50.00 ml	±0.3	≤ 0.15

The above-mentioned technical data apply only when the Combitip plus is being used. Test conditions and test evaluation in compliance with ISO 8655, Part 6; test using a standardized fine balance with a moisture trap.

Volume tests in Dis mode; set speed levels: 7; number of determinations: 10; use of water in accordance with ISO 3696; test at 20 °C – 25 °C ±0.5 °C; dispensing against the tube wall.

Note: the test volumes for systematic and random error of the Multipette plus are not identical using the Multipette stream / Xstream. The different selection of published test volumes is attributable to corresponding specifications in ISO 8655, Part 5.

Multipette® stream / Xstream – 8 Technical Data

Battery

Lithium-ion battery; 750 mAh / 3.7 V;
overload protection in conjunction with the Multipette stream/Xstream;
charging time approx. 2 hours

Up to 2000 dispensing operations are possible with a fully-charged battery and at maximum aspiration and dispensing speed.

Power supply device

Universal power supply device with power plug adapter which can be inserted;
input voltage: 100–240 V \pm 10 % / 50/60 Hz;
output voltage: 5 V / 1.0 A

Multipette stream / Xstream

Storage temperature $-10\text{ }^{\circ}\text{C}$ to $+45\text{ }^{\circ}\text{C}$;
humidity between 10 and 92 %

Operating temperature
 $+5\text{ }^{\circ}\text{C}$ to $+40\text{ }^{\circ}\text{C}$; humidity between 20 and 92 %

Errors and omissions excepted; technical specifications subject to change!

Multipette® stream / Xstream – 9 Ordering Information

9.1 Ordering Information

Description	Order no.	Order no.
Multipette® stream , includes charging adapter, 100–240 V / 50–60 Hz	4986 000.017	
Multipette® Xstream , includes charging adapter, 100–240 V / 50–60 Hz	4986 000.025	
Charging stand for one Multipette stream or Xstream	4986 000.262	
Li-ion-battery	4986 602.009	
Power supply	4986 601.002	
Combitips® plus tips	Standard (set of 100)	Eppendorf Biopur® (individually wrapped, set of 100)
0.1 ml	0030 069.200	0030 069.404
0.2 ml	0030 069.218	0030 069.412
0.5 ml	0030 069.226	0030 069.420
1 ml	0030 069.234	0030 069.439
2.5 ml	0030 069.242	0030 069.447
5.0 ml	0030 069.250	0030 069.455
10 ml	0030 069.269	0030 069.463
25 ml	0030 069.293	0030 069.390
50 ml	0030 069.277	0030 069.471
25 ml adapter (1 piece), blue	0030 069.528	
50 ml adapter (1 piece) gray	0030 069.161	
25 ml adapter (set of 7)		0030 069.498
50 ml adapter (set of 7)		0030 069.480
Combitips plus tips assortment pack , includes five of each size plus one 50 ml and one 25 ml adapter	0030 069.285	
Combilong (set of two) , aspirating aid for removing liquids from volumetric flasks and tall bottles; Combitip plus tips sizes 5 ml, 25 ml and 50 ml	0030 069.506	
Combitip-Rack , for mounting Combitips plus tips	0030 069.897	

Multipette® stream / Xstream – 10 Storage and Disposal

10.1 Storage

Over a prolonged period, the device may only be stored at ambient temperature between $-10\text{ }^{\circ}\text{C}$ and $+45\text{ }^{\circ}\text{C}$ and at a maximum humidity of 92 %.

10.2 Disposal

In case the product is to be disposed of, the relevant legal regulations are to be observed.

Information on the disposal of electrical and electronic devices in the European Community

The disposal of electrical devices is regulated within the European Community by national regulations based on EU Directive 2002/96/EC on waste electrical and electronic equipment (WEEE).

According to these regulations, any devices supplied after 13.08.05 in the business-to-business sphere, to which this product is assigned, may no longer be disposed of in municipal or domestic waste. Multipette stream / Xstream are marked with the following symbol to indicate this:



As disposal regulations within the EU may vary from country to country, please contact your supplier if necessary.

Multipette® stream / Xstream – 11 EC Conformity Declaration

11

EC Conformity Declaration

EG-Konformitätserklärung EC Conformity Declaration

Das bezeichnete Produkt entspricht den einschlägigen grundlegenden Anforderungen der aufgeführten EG-Richtlinien und Normen. Bei einer nicht mit uns abgestimmten Änderung des Produktes oder einer nicht bestimmungsgemäßen Anwendung verliert diese Erklärung ihre Gültigkeit.

The product named below fulfills the relevant fundamental requirements of the EC directives and standards listed. In the case of unauthorized modifications to the product or an unintended use this declaration becomes invalid.

Produktbezeichnung, Product name:

Multipette® stream, Multipette® Xstream

Produkttyp, Product type:

Elektronischer Handdispenser / Electrical manual dispenser

Einschlägige EG-Richtlinien/Normen, Relevant EC directives/standards:

89/336/EWG, EN 55011, EN 61000-6-1, EN 61326/A1, 73/23EWG, EN 61010-1

98/79/EG, EN 14971, EN 591, EN 61010-2-101, EN ISO 8655-5

H.-G. Köh

Vorstand, Board of Management:

25.04.2006

Hamburg, Date:

Jörg Richter

Projektmanagement, Project Management:



eppendorf

Eppendorf AG · Barkhausenweg 1 · 22339 Hamburg · Germany

0015 033 509-02

4986 900 999-00

Eppendorf Offices

ASEAN

Eppendorf AG
Regional Office in Malaysia
Tel. +60 3 8023 2769
Fax +60 3 8023 3720
E-Mail: eppendorf@eppendorf.com.my
Internet: www.eppendorf.com.my

AUSTRALIA / NEW ZEALAND

Eppendorf South Pacific Pty. Ltd.
Tel. +61 2 9889 5000
Fax +61 2 9889 5111
E-mail: Info@eppendorf.com.au
Internet: www.eppendorf.com.au

AUSTRIA

Eppendorf AG
c/o Schott Austria
Tel. +43 1 29017560
Fax +43 1 290175620
E-Mail: gilch.p@eppendorf.de
Internet: www.eppendorf.com

BRAZIL

Eppendorf do Brasil Ltda.
Tel. +55 11 30 95 93 44
Fax +55 11 30 95 93 40
E-Mail:
eppendorf@eppendorf.com.br
Internet: www.eppendorf.com.br

CANADA

Eppendorf Canada, Ltd.
Tel. +1 905 826 5525
Fax +1 905 826 5424
E-Mail: canada@eppendorf.com
Internet: www.eppendorf.com

CHINA

Eppendorf AG
Tel. +86 21 68760880
Fax +86 21 50815371
E-Mail: market.info@eppendorf.cn
Internet: www.eppendorf.cn

FRANCE

EPPENDORF FRANCE S.A.R.L.
Tel. +33 1 30 15 67 40
Fax +33 1 30 15 67 45
E-Mail: eppendorf@eppendorf.fr
Internet: www.eppendorf.fr

GERMANY

Eppendorf Vertrieb
Deutschland GmbH
Tel. +49 2232 418-0
Fax +49 2232 418-155
E-Mail: vertrieb@eppendorf.de
Internet: www.eppendorf.de

INDIA

Eppendorf India Limited
Tel. +91 44 52111314
Fax +91 44 52187405
E-Mail: info@eppendorf.co.in
Internet: www.eppendorf.co.in

ITALY

Eppendorf s.r.l.
Tel. +390 2 55 404 1
Fax +390 2 58 013 438
E-Mail: eppendorf@eppendorf.it
Internet: www.eppendorf.it

JAPAN

Eppendorf Japan Co. Ltd.
Tel. +81 3 5825 2363
Fax +81 3 5825 2365
E-Mail: info@eppendorf.jp
Internet: www.eppendorf.jp

NORDIC

Eppendorf Nordic Aps
Tel. +45 70 22 2970
Fax +45 45 76 7370
E-Mail: nordic@eppendorf.dk
Internet: www.eppendorf.dk

SPAIN

Eppendorf Ibérica S.L.
Tel. +34 91 651 76 94
Fax +34 91 651 81 44
E-Mail: iberica@eppendorf.de
Internet: www.eppendorf.es

SWITZERLAND

Vaudaux-Eppendorf AG
Tel. +41 61 482 1414
Fax +41 61 482 1419
E-Mail: vaudaux@vaudaux.ch
Internet: www.eppendorf.com

UNITED KINGDOM

Eppendorf UK Limited
Tel. +44 1223 200 440
Fax +44 1223 200 441
E-Mail: sales@eppendorf.co.uk
Internet: www.eppendorf.co.uk

USA

Eppendorf North America
Tel. +1 516 334 7500
Fax +1 516 334 7506
E-Mail: info@eppendorf.com
Internet: www.eppendorfna.com

OTHER COUNTRIES

see:
www.eppendorf.com/worldwide

eppendorf

In touch with life

Your local distributor: www.eppendorf.com/worldwide

Eppendorf AG · 22331 Hamburg · Germany · Tel. +49 40 538 01-0 · Fax +49 40 538 01-556
E-Mail: eppendorf@eppendorf.com

Eppendorf North America, Inc. · One Cantiague Road, P.O. Box 1019 · Westbury, N.Y. 11590-0207 USA
Tel. +1 516 334 7500 · Toll free phone 800 645 3050 · Fax +1 516 334 7506 · E-Mail: info@eppendorf.com

Application Support

Europe, International: Tel. +49 1803 666 789 · E-Mail: support@eppendorf.com
North America: Tel. 800 645 3050 ext. 2258 · E-Mail: support_NA@eppendorf.com
Asia, Pacific: Tel. +603 8023 2769 · E-Mail: support_Asia@eppendorf.com