

Register your instrument!  
[www.eppendorf.com/myeppendorf](http://www.eppendorf.com/myeppendorf)



## Eppendorf Xplorer® Eppendorf Xplorer® plus

Operating manual

Copyright© 2016 Eppendorf AG, Germany. All rights reserved, including graphics and images. No part of this publication may be reproduced without the prior permission of the copyright owner.

Eppendorf® and the Eppendorf logo are registered trademarks of Eppendorf AG, Germany.

epT.I.P.S.® and Eppendorf Xplorer® are registered trademarks of Eppendorf AG, Germany.

Registered trademarks and protected trademarks are not marked in all cases with ® or ™ in this manual.

U.S. Patents are listed on [www.eppendorf.com/ip](http://www.eppendorf.com/ip)

U.S. Design Patents are listed on [www.eppendorf.com/ip](http://www.eppendorf.com/ip)

**Table of contents**

<b>1</b>	<b>Operating instructions</b> .....	<b>7</b>
1.1	Using this manual.....	7
1.2	Danger symbols and danger levels.....	7
1.2.1	Danger symbols.....	7
1.2.2	Danger levels.....	7
1.3	Symbols used.....	7
1.4	Glossary.....	8
<b>2</b>	<b>Safety</b> .....	<b>11</b>
2.1	Intended use.....	11
2.2	Warnings for intended use.....	11
2.3	Information on product liability.....	13
<b>3</b>	<b>Product description</b> .....	<b>14</b>
3.1	Main illustration – single-channel pipette.....	14
3.2	Main illustration – multi-channel pipette.....	15
3.3	Delivery package.....	16
3.3.1	Single-channel pipettes – additional delivery package.....	16
3.3.2	Multi-channel pipettes – additional delivery package.....	16
3.4	Features.....	16
3.5	RFID chip.....	17
3.5.1	RFID position.....	17
3.6	Display.....	17
3.6.1	Header.....	18
3.6.2	Status bar.....	19
3.6.3	Main field.....	19
3.6.4	Footer.....	19
3.7	Warranty.....	20
3.8	Materials.....	20
<b>4</b>	<b>Installation</b> .....	<b>21</b>
4.1	Mains/power supply device assembly.....	21
4.2	Connecting the Lithium-polymer rechargeable battery.....	21
4.3	Charging the rechargeable battery.....	22

## Table of contents

### 4 Eppendorf Xplorer®/Eppendorf Xplorer® plus English (EN)

<b>5</b>	<b>Operation</b>	<b>24</b>
5.1	Switching the pipette on or off	24
5.1.1	Switching on	24
5.1.2	Switching off	24
5.2	Setting the Date and Time (Xplorer plus)	24
5.3	Principle of operation	25
5.4	Selecting the operating mode	25
5.5	Setting the parameters (edit mode)	27
5.5.1	Xplorer/Xplorer plus	27
5.5.2	Xplorer plus	30
5.6	Recommended pipette tips	31
5.7	Using pipette tips	32
5.8	Volume limit in the case of pipette tips with a filter	33
5.9	Tips for correct pipetting	33
5.9.1	Preparing pipetting	33
5.9.2	Aspirating liquid	34
5.9.3	Dispensing liquid	34
5.10	Automatic dispensing (Ads selection dial setting)	36
5.11	Dispensing of liquid – Dis selection dial setting	37
5.12	Pipetting of liquid – Pip selection dial setting	38
5.12.1	Standard pipetting	38
5.12.2	Reverse pipetting (Xplorer)	40
5.13	Pipetting and mixing of liquids – P/M selection dial setting	41
5.14	Manual pipetting of liquid – Man selection dial setting	42
5.15	Special operating modes (Xplorer plus)	43
5.15.1	Multiple aspiration of liquid (Aspirate) – Spc selection dial setting	43
5.15.2	Diluting liquid (Diluting) – Spc selection dial setting	44
5.15.3	Sequential dispensing of liquid – Spc selection dial setting	46
5.15.4	Reverse pipetting of liquid – Spc selection dial setting	47
5.15.5	Sequential pipetting of liquid – Spc selection dial setting	48
5.16	Executing the saved program – Prg selection dial setting (Xplorer plus)	49
5.17	Editing the program – Edit selection dial setting (Xplorer plus)	49
5.17.1	Pswrd. protection	50
5.17.2	Creating or changing Fixed volume	50
5.17.3	Creating or changing Program	51
5.18	Pipetting with fixed volume – Fix selection dial setting (Xplorer plus)	52

5.19	Option – Opt selection dial setting . . . . .	52
5.19.1	General help – calling a description of the modes . . . . .	53
5.19.2	Volume limit – setting the volume limit. . . . .	53
5.19.3	Counter – switching the counter for dispensing steps on/off . . . . .	55
5.19.4	Ejector reset labware . . . . .	55
5.19.5	Rocker setting – setting the speed of the rocker . . . . .	55
5.19.6	History – saving and displaying dispensing settings . . . . .	55
5.19.7	Setting the Sound level . . . . .	55
5.19.8	Setting the Brightness (display) . . . . .	55
5.19.9	Setting the Adjustment . . . . .	56
5.19.10	Language – setting the language . . . . .	59
5.19.11	Personalization – personalizing the pipette. . . . .	59
5.19.12	Service – calling up service functions . . . . .	59
5.19.13	Activating the Service interval (Xplorer plus) . . . . .	59
5.19.14	Setting the Date and Time (Xplorer plus) . . . . .	60
5.20	Resetting the pipette to the factory setting. . . . .	60
5.20.1	Performing Initial reset – Opt selection dial setting . . . . .	60
<b>6</b>	<b>Troubleshooting . . . . .</b>	<b>61</b>
6.1	Reset . . . . .	61
6.2	Error search. . . . .	61
6.2.1	Rechargeable battery. . . . .	61
6.2.2	Display. . . . .	62
6.2.3	Liquid. . . . .	63
6.2.4	Pipette . . . . .	64
6.2.5	Software. . . . .	64
<b>7</b>	<b>Maintenance. . . . .</b>	<b>65</b>
7.1	Preserving the battery capacity. . . . .	65
7.1.1	Longer periods without operation – with charger stand. . . . .	65
7.1.2	Longer periods without operation – without charger stand . . . . .	65
7.1.3	Replacing the rechargeable battery . . . . .	65
7.2	Cleaning . . . . .	66
7.2.1	Cleaning and disinfecting the pipette . . . . .	66
7.2.2	Cleaning and disinfecting the lower part . . . . .	67
7.2.3	Sterilizing the pipette with UV light . . . . .	67
7.3	Sterilizing or disinfecting the pipette . . . . .	67
7.3.1	Autoclaving . . . . .	68
7.3.2	Disinfection . . . . .	68
7.4	Replacing O-rings . . . . .	69
7.4.1	Removing the O-ring . . . . .	69
7.4.2	Mounting a new O-ring . . . . .	69
7.5	Xplorer disassembly and assembly. . . . .	70
7.5.1	Single-channel up to 1000 µL . . . . .	70
7.5.2	5 mL and 10 mL single-channel . . . . .	73
7.5.3	Multi-channel. . . . .	75

**6 Table of contents**  
Eppendorf Xplorer®/Eppendorf Xplorer® plus  
English (EN)

7.6	Lubricating the piston or cylinder. . . . .	80
7.6.1	Lubricating the piston . . . . .	80
7.6.2	Lubricating the cylinder . . . . .	80
7.7	Maintenance . . . . .	80
<b>8</b>	<b>Technical data . . . . .</b>	<b>81</b>
8.1	Measurement errors of the single-channel pipette. . . . .	81
8.2	Measurement errors of the multi-channel pipette . . . . .	82
8.3	Test conditions . . . . .	82
8.4	Technical data of the pipette. . . . .	83
8.4.1	Ambient conditions . . . . .	83
8.4.2	Weight . . . . .	83
8.4.3	Power supply . . . . .	83
8.4.4	Rechargeable battery. . . . .	83
8.5	Dispensing speeds . . . . .	84
8.5.1	Single-channel pipettes . . . . .	84
8.5.2	Multi-channel pipettes. . . . .	84
<b>9</b>	<b>Transport, storage and disposal . . . . .</b>	<b>85</b>
9.1	Decontamination before shipment . . . . .	85
9.2	Storage . . . . .	86
9.3	Disposal. . . . .	86
<b>10</b>	<b>Ordering information. . . . .</b>	<b>88</b>
	<b>Index. . . . .</b>	<b>90</b>
	<b>Certificates . . . . .</b>	<b>93</b>

## 1 Operating instructions







### 1.1 Using this manual

- ▶ Read this operating manual completely before using the device for the first time. Also observe the instructions for use of the accessories.
- ▶ This operating manual is part of the product. Thus, it must always be easily accessible.
- ▶ Enclose this operating manual when transferring the device to third parties.
- ▶ You will find the current version of the operating manual for all available languages on our website under [www.eppendorf.com/manuals](http://www.eppendorf.com/manuals).
- ▶ This operating manual applies to devices with software version 2.06.00 or higher.

### 1.2 Danger symbols and danger levels

#### 1.2.1 Danger symbols



The safety instructions in this manual have the following danger symbols and danger levels:

	<b>Biohazard</b>		<b>Explosive substances</b>
	<b>Electric shock</b>		<b>Toxic substances</b>
	<b>Hazard point</b>		<b>Material damage</b>

#### 1.2.2 Danger levels

<b>DANGER</b>	<i>Will</i> lead to severe injuries or death.
<b>WARNING</b>	<i>May</i> lead to severe injuries or death.
<b>CAUTION</b>	May lead to light to moderate injuries.
<b>NOTICE</b>	May lead to material damage.

### 1.3 Symbols used

Depiction	Meaning
1. 2.	Actions in the specified order
▶	Actions without a specified order
•	List
	Direction of movement
<i>Text</i>	Display text or software text
	Additional information

## 1.4 Glossary

### A

#### **Additional volume**

The total of the remaining stroke and the reverse stroke.

### B

#### **Biopur**

Eppendorf Biopur® is an Eppendorf AG purity level for consumables. Eppendorf Biopur® meets the requirements for standard products, e.g., precision, accuracy, wetting behavior, tightness. Eppendorf Biopur® also meets the requirements with regard to sterility, absence of ATP, PCR inhibitors, human and bacterial DNA, pyrogens, DNase and RNase. Consumables with the Biopur purity grade are controlled and certified by an external laboratory.

Certificates are available from our website [www.eppendorf.com](http://www.eppendorf.com).

#### **Blow out**

The piston moves to the lowest position in order to blow out the residual liquid from the pipette tip. During pipetting operations, the liquid from the blow-out is part of the dispensing volume. During reverse pipetting operations, the liquid is **not** part of the dispensing volume.

### C

#### **Cycle**

Together, the upward piston movement (liquid aspiration) and downward piston movement (liquid dispensing) form a cycle.

### F

#### **Free jet dispensing**

Dispensing of liquid without the dispensing tip (pipette tip, dispenser tip) touching the tube inner wall.

### I

#### **Increment**

Step size or resolution. The smallest possible change by which a value can be increased.

#### **ISO 8655**

The standard defines limit values for the systematic error, the random error and the test methods for dispensers.



## L

### **Lithium polymer rechargeable battery**

Special configuration of a lithium-ion battery. Like rechargeable lithium-ion batteries, rechargeable lithium-polymer-batteries have a very high charging capacity and a long service life. The special encapsulation of the lithium polymer rechargeable battery makes it lighter than rechargeable lithium-ion batteries.

## N

### **Nominal volume**

The maximum dispensing volume of a dispensing system specified by the manufacturer.

## P

### **PCR clean**

PCR clean is an Eppendorf AG purity grade for consumables. PCR clean meets the requirements for standard products, e.g., precision, accuracy, wetting behavior, leak tightness. PCR clean also meets the requirements with regard to absence of human DNA, DNase, RNase and PCR inhibitors.

Consumables with the PCR clean purity grade are controlled and certified by an external laboratory.

Certificates are available from our website [www.eppendorf.com](http://www.eppendorf.com).

### **PhysioCare Concept®**

Products that carry the Eppendorf PhysioCare Concept logo feature optimized ergonomics and make operation as simple as possible, even with complex dispensing tasks. PhysioCare products can be easily serviced and cleaned. They are made of extremely light materials and require minimal operating force.

## R

### **Remaining stroke**

Liquid reserve. The liquid which remains after all dispensing steps have been completed.

### **Reverse stroke**

After liquid aspiration, the piston is moved to a defined initial position. Liquid is dispensed during the piston movement. The reverse stroke is not a dispensing step.

## S

### **Sterile**

Sterile is an Eppendorf AG purity grade for consumables. Sterile meets the requirements for standard products, e.g., precision, accuracy, wetting behavior, leak tightness. Sterile also meets the requirements with regard to sterility and freedom from pyrogens.

## **V**

### **Vapor pressure**

This term refers to the pressure exerted by the vapor of a material (solid or liquid) in an enclosed container. The vapor is in equilibrium with the solid or liquid phase of the material. The vapor pressure increases when the temperature increases. Each pure liquid has a vapor pressure of 1013 hPa (mbar) at boiling point. Volume errors caused by high vapor pressure can be reduced by prewetting the tip.

### **Viscosity**

Viscosity describes the viscosity of liquids and suspensions. The dynamic or absolute viscosity is indicated in Pa·s or in mPa·s. In older literature, the unit P or cP is used (1 mPa·s corresponds to 1 cP). At ambient temperature, a 50 % glycerol solution has a viscosity of approx. 6 mPa·s. As the glycerol concentration increases, viscosity increases considerably. Absolutely anhydrous glycerol has a viscosity of approx. 1480 mPa s at ambient temperature.

## 2 Safety

### 2.1 Intended use

The Xplorer/Xplorer plus is a lab device intended for dispensing liquids in the volume range from 0.5 µL to 10 mL in combination with matching pipette tips. In-vivo applications (in or on the human body) are not allowed

Only appropriately qualified personnel are allowed to use the Xplorer/Xplorer plus. All users must have read the operating manual carefully and familiarized themselves with the device's mode of operation.

### 2.2 Warnings for intended use

---



#### **DANGER! Risk of explosion.**

- ▶ Do not operate the device in areas where work is completed with explosive substances.
  - ▶ Do not use this device to process any explosive or highly reactive substances.
  - ▶ Do not use this device for processing any substances which could generate an explosive atmosphere.
- 



#### **WARNING! Damage to health from infectious liquids and pathogenic germs.**

- ▶ When handling infectious liquids and pathogenic germs, observe the national regulations, the biological security level of your laboratory, the Material Safety Data Sheets, and the manufacturer's application notes.
- ▶ Wear your personal protective equipment.
- ▶ Consult the "Laboratory Biosafety Manual" (source: World Health Organization, Laboratory Biosafety Manual, as amended) for comprehensive regulations on the handling of germs or biological materials of risk group II or higher.



#### **WARNING! Damage to health due to toxic, radioactive or aggressive chemicals.**

- ▶ Wear your personal protective equipment.
- ▶ Observe the national regulations for handling these substances.
- ▶ Observe the material safety data sheets and manufacturer's application notes.

**WARNING! Personal injury caused by incorrect handling of the rechargeable battery.**

- ▶ Never pierce, crush or throw the rechargeable battery.
  - ▶ Only use the rechargeable battery in the supplied device.
  - ▶ Do not touch a leaking rechargeable battery.
  - ▶ Do not use a damaged rechargeable battery.
  - ▶ Dispose of rechargeable batteries according to the legal requirements.
- 

**CAUTION! Danger to individuals due to careless use**

- ▶ Never point the opening of the device toward yourself or others.
- ▶ Only initiate liquid dispensing if it is safe to do so.
- ▶ With any dispensing task please ensure that you do not endanger yourself and other persons.

**CAUTION! Poor safety due to incorrect accessories and spare parts.**

The use of accessories and spare parts other than those recommended by Eppendorf may impair the safety, functioning and precision of the device. Eppendorf cannot be held liable or accept any liability for damage resulting from the use of incorrect or non-recommended accessories and spare parts, or from the improper use of such equipment.

- ▶ Only use accessories and original spare parts recommended by Eppendorf.
- 

**NOTICE! Damage to device from missing pipette tips.**

- ▶ Use the pipette with fitted pipette tips only.

**NOTICE! Carry-over, contamination and incorrect dispensing results due to the incorrect use of pipette tips.**

The pipette tips are for single use only. Prolonged use can have a negative impact on dispensing tasks.

- ▶ Only use the pipette tips once.
- ▶ Do not use autoclaved ep Dualfilter T.I.P.S. for dispensing.

**NOTICE! Damage to the device due to penetration of liquids.**

- ▶ Do not set the pipette aside when the pipette tip is filled.
  - ▶ Do not allow any liquids to penetrate the inside of the housing.
-

### **2.3 Information on product liability**

In the following cases, the designated protection of the device may be compromised. Liability for any resulting property damage or personal injury is then transferred to the operator:

- The device is not used in accordance with the operating manual.
- The device is used outside of its intended use.
- The device is used with accessories or consumables which are not recommended by Eppendorf.
- The device is maintained or repaired by people not authorized by Eppendorf.
- The user makes unauthorized changes to the device.

**3 Product description**

**3.1 Main illustration – single-channel pipette**

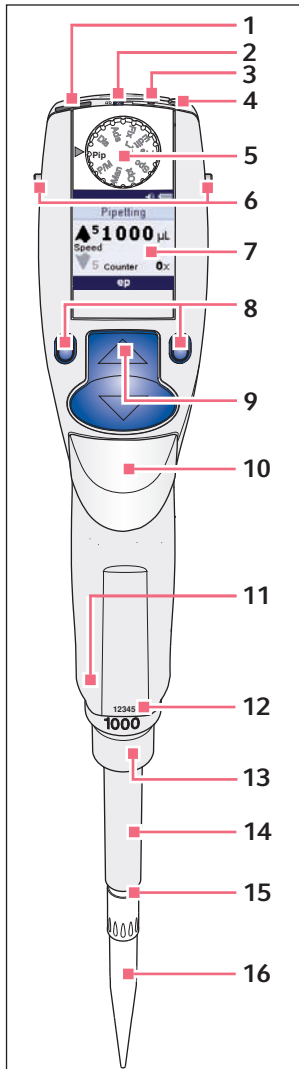

**1 USB port**

**2 On/Off key**

**3 Reset key**

**4 Connector socket**

Connects the charging plug of the power supply.

**5 Selection dial**

Sets the operating mode.

**6 Charging contacts**

For charging and storage in a series 4880 charger stand or charger carousel.

**7 Backlit color display**

Switches the display off when it is not in use. The display automatically switches back on when the pipette is moved.

**8 Softkeys**

The assignment of the respective softkey is shown in the display footer.

**9 Rocker**

You can either press the rocker up or down. The rocker can either be used to trigger the piston movement or to scroll through the menu and change the values of parameters.

**10 Ejector**

Moves the ejector sleeve and ejects the pipette tip. After a filled pipette tip has been ejected, the piston returns to the basic position after a slight delay.

**11 RFID chip**

**12 Upper part serial number**

**13 Lower part serial number**

Located under the ejector sleeve.

**14 Ejector sleeve**

**15 Spring-loaded tip cone**

The spring-loading action optimizes the force required for attaching and ejecting tips. The spring-loading action is available for all Xplorer pipettes up to 1000 µL.

**16 Pipette tip**

Only use the pipette with a suitable pipette tip. We recommend epT.I.P.S.

### 3.2 Main illustration – multi-channel pipette

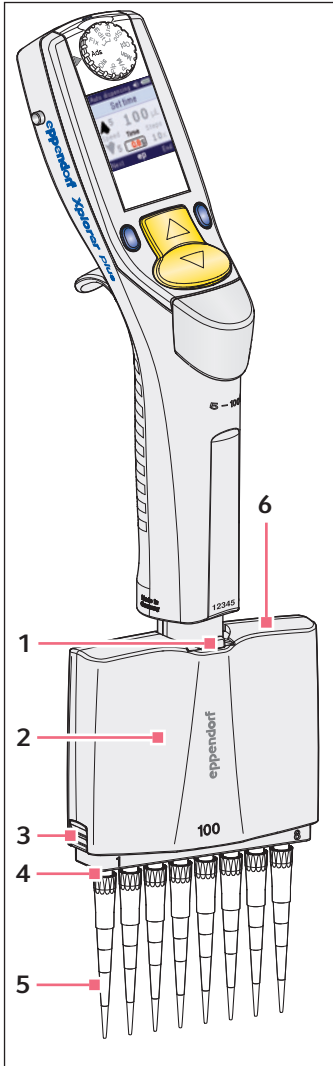

For a description of the upper part, refer to the main illustration of the single-channel pipette.

#### 1 Lever

The lever is used to release the multi-channel lower part.

#### 2 Multi-channel lower part

The multi-channel lower part is freely rotatable. It is not detached when rotated. The outer channels are marked with the numbers 1 and 8 (or 12). The multi-channel version has a piston for each channel so that less than 8 or 12 tips can also be mounted.

You can open the multi-channel lower part in order to exchange or remove individual channels.

The multi-channel lower part is autoclavable.

#### 3 Latches, right and left

To release the cover plate with the interior ejector rail.

The 1200  $\mu\text{L}$  multi-channel lower part can be opened with a pin.

#### 4 Tip cones with spring-loading action

The spring-loading action optimizes the force required for attaching and ejecting tips. The spring-loading action is present for the 10  $\mu\text{L}$ , 100  $\mu\text{L}$  and 300  $\mu\text{L}$  pipettes.

#### 5 Pipette tips

We recommend epT.I.P.S.

#### 6 Cover plate for 10 $\mu\text{L}$ , 100 $\mu\text{L}$ and 300 $\mu\text{L}$

Removable cover plate with internal ejector rail.

The cover plate is opposite the side with the lever.

**Product description**

Eppendorf Xplorer®/Eppendorf Xplorer® plus  
English (EN)

**3.3 Delivery package**

Quantity	Description
1	Eppendorf Xplorer or Eppendorf Xplorer plus
1	Power supply with power plug adapters
1	Operating manual
1	Short instructions

**3.3.1 Single-channel pipettes – additional delivery package**

Quantity	Description
1	Locking ring (deactivate the spring-loading action at $\leq 1000 \mu\text{L}$ )
1	Protection filter (1 filter sleeve, 10 filters, at 5 mL and 10 mL)
1	Pipette wrench (open lower part and remove filter sleeve at 5 mL and 10 mL)

**3.3.2 Multi-channel pipettes – additional delivery package**

Quantity	Description
1	Multi-channel tool for cutting the O-rings on the tip cones (from $100 \mu\text{L}$ )
1	Unlocking tool for opening the multi-channel lower part (at $1200 \mu\text{L}$ )
2 or 3	Locking clip for deactivating the spring-loading action (at $10 \mu\text{L}$ , $100 \mu\text{L}$ and $300 \mu\text{L}$ )

**3.4 Features**

The Xplorer pipettes are motor-driven and electronically-controlled piston-stroke pipettes for aspirating and dispensing liquids according to the air cushion principle. The Xplorer pipette family includes single-channel and multi-channel pipettes (8 or 12 channels). Depending on the Xplorer pipette, volumes from  $0.5 \mu\text{L}$  to  $10 \text{ mL}$  can be dispensed. The liquid is aspirated into a pipette tip which has been fitted to the Xplorer pipette.

The central operating control of the Xplorer pipette is a rocker switch. The color of the rocker switch varies according to the volume range of the Xplorer Pipette. The rocker switch has different functions during dispensing and when editing the dispensing parameters. It can either be pushed upwards or downwards.

The lower parts of the Xplorer pipettes can be autoclaved.

On all Xplorer pipettes with a nominal volume of  $10 \mu\text{L}$  to  $1000 \mu\text{L}$ , the tip cone has a spring-loading action when a pipette tip is attached.

A protection filter can be inserted in  $5 \text{ mL}$  and  $10 \text{ mL}$  Xplorer pipettes to protect the tip cone against liquids.



### 3.5 RFID chip

The Eppendorf dispensing device is equipped with a RFID chip. The RFID chip can be read and written with the TrackIT reader and TrackIT software. The scanned device data is saved in a database and can be opened at any time. The device data can be exported individually or automatically in various formats.

#### 3.5.1 RFID position

The position of the chip on dispensing devices is marked with the lettering **RFID**.

### 3.6 Display

The brightness of the display can be changed in the options. The display dims during usage intervals and switches off after a prolonged usage interval. Move the Xplorer pipette to switch the display back on.

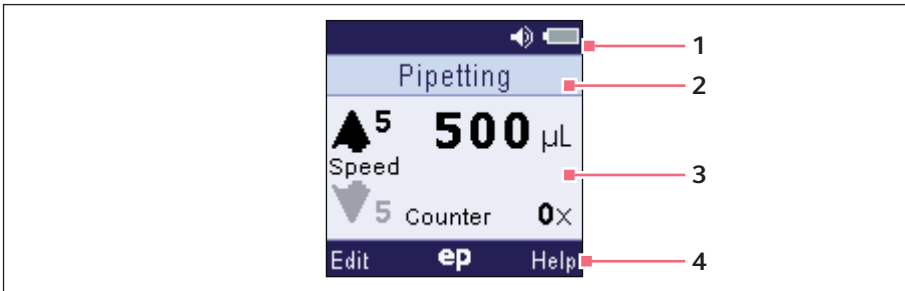









- |  |   |
|--|---|
| <p><b>1 Header</b><br/>                 Adjustment, type of adjustment, volume<br/>                   Acoustic signal, charging status</p> | <p><b>3 Main field</b><br/>                 Dispensing speed, dispensing volume,<br/>                 number of dispensing procedures</p> |
| <p><b>2 Status bar</b><br/>                 Operating mode or parameter</p>  | <p><b>4 Footer</b><br/>                 Softkeys</p>  |

**Product description**

Eppendorf Xplorer®/Eppendorf Xplorer® plus  
English (EN)

**3.6.1 Header**

<b>Adjustment</b>	
	Symbol for changed factory adjustment. The type of adjustment is shown on the right
<b>Type of adjustment</b>	
	<i>1-point adjust.</i> Single-point adjustment by the user.
	<i>2-point adjust.</i> Two-point adjustment by the user.
	<i>3-point adjust.</i> Three-point adjustment by the user.
	<i>Glycerol 50%</i> Adjustment to liquid type 50% glycerol.
	<i>Ethanol 75%</i> Adjustment to liquid type 75% ethanol.
	<i>Altitude</i> Adjustment to an altitude other than 0 m above sea level.
	<i>epTIPS long</i> Adjustment to an epT.I.P.S. long.





The adjustment can be changed in the options. Detailed information can be found on our webpage [www.eppendorf.com/manuals](http://www.eppendorf.com/manuals).

**Volume**

	Acoustic feedback The selected volume for the acoustic feedback can be set in the options. If the volume has been set to 0, no loudspeaker symbol is displayed.
--	---

**Rechargeable battery**

	Rechargeable battery fully charged.
	Rechargeable battery partially discharged.
	Rechargeable battery almost discharged. Rechargeable battery must be charged.

### 3.6.2 Status bar

The selected operating mode is displayed here during operation. In edit mode, the name of the parameter to be edited is displayed.

### 3.6.3 Main field

All parameters of the operating mode are displayed simultaneously during dispensing. A black arrow ▼▲ indicates the direction of the next piston movement.

In edit mode, the parameter to be edited is marked in red.

Some of the dispensing parameters in the main field include:

- Dispensing volume
- *Speed*: 8 speeds for aspiration and dispensing.
- *Counter* Number of conducted dispensing steps. Optional setting in the **Pip** mode.

### 3.6.4 Footer

Assignment of the softkeys with variable functions.

Some of the softkeys in the footer are:

- *Edit*: Open the edit mode.
- *Next*: Select next parameter.
- *End*: Exit the edit or help mode.
- *Help*: Show help.
- *History*: Display the last dispensing settings of the accessed mode .



The right softkey can be assigned to *Help* or *History*. The assignment of the softkey can be defined in the options (**Opt**). The softkey is assigned to *Help* when delivered.

If the right *Help* softkey is activated, the softkey can be used to display information on the selected operating mode.

If the *History* softkey is activated, it can be used to call the most recently executed dispensing operations.

**Product description**

Eppendorf Xplorer®/Eppendorf Xplorer® plus  
English (EN)

**3.7 Warranty**

In case of warranty claims, contact your local Eppendorf contractual partner.

No warranty is given in the following cases:

- In the case of misuse.
- If unauthorized persons open the upper part.

The following assemblies are excluded from the warranty:

- Wear parts
- Rechargeable battery

**3.8 Materials**

**NOTICE! Aggressive substances may damage the pipette, pipette tip and accessories.**

- ▶ Check the resistance to chemicals before using organic solvents or aggressive chemicals.
- ▶ Only use liquids whose vapors do not corrode the used materials.
- ▶ Observe the cleaning instructions.

The components of the Xplorer which can be accessed by the user are made of the following materials:

<b>Component</b>	<b>Material</b>
External surfaces of the upper part	<ul style="list-style-type: none"> <li>• Improved polypropylene (PP)</li> <li>• Polycarbonate (PC)</li> <li>• Polycarbonate (PC), coated</li> <li>• Polycarbonate (PC), dyed</li> <li>• Gold plated</li> </ul>
Exterior and interior of lower parts	<ul style="list-style-type: none"> <li>• Improved polypropylene (PP)</li> <li>• Polyvinylidene fluoride (PVDF)</li> <li>• Polyetherimide (PEI)</li> <li>• Polyphenylene sulfide (PPS)</li> <li>• Polyetheretherketone (PEEK)</li> <li>• Polytetrafluoroethylene (PTFE)</li> <li>• Ethylene propylene diene rubber (EPDM)</li> <li>• Silicone</li> <li>• Steel (stainless steel and spring steel)</li> </ul>

## 4 Installation

### 4.1 Mains/power supply device assembly

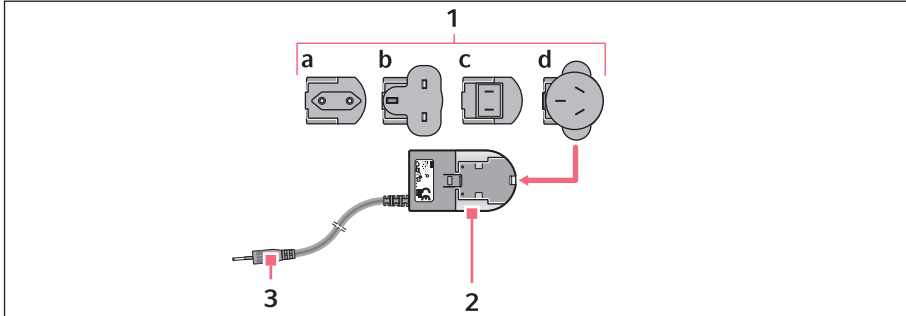

#### 1 Power plug adapters

- a EU
- b United Kingdom
- c USA
- d Australia

#### 3 Charging plug

#### 2 Mains/power supply device

- ▶ Insert the power plug adapter required for your mains/power supply into the opening of the mains/power supply device. If there is any doubt as to which power plug adapter should be used for the power supply unit, you should consult an electrician.

### 4.2 Connecting the Lithium-polymer rechargeable battery

The lithium polymer battery is already inserted in the battery compartment upon delivery.

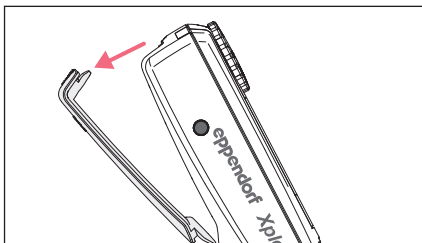

1. Open the rechargeable battery compartment cover.

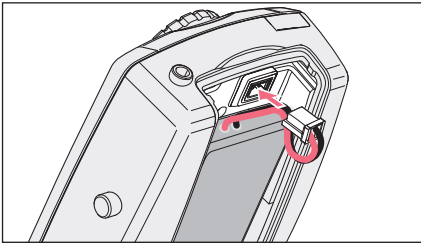

2. Connect the plug of the rechargeable lithium polymer battery to the connector socket.
  3. Close the rechargeable battery compartment cover.
- On the Xplorer plus pipette, you will then be prompted to set the date and time (see p. 24).

### 4.3 Charging the rechargeable battery



**WARNING! Incorrect or damaged mains/power supply devices may lead to severe personal injuries and damage to the device.**

Incorrect or damaged mains/power supply devices may cause electric shock, overheat the device, set it to fire, melt it, short-circuit it or cause similar damage.

- ▶ Only the supplied mains/power supply device may be used to charge the device. You can identify the correct mains/power supply device by the Eppendorf logo and the device name on the mains/power supply device.
- ▶ Do not use damaged mains/power supply devices.



**NOTICE! Loss of full battery charging capacity of the rechargeable battery if charged incorrectly.**

The supplied rechargeable battery is not fully charged. The rechargeable battery will reach its full capacity only after several discharging and charging cycles.

- ▶ Do not charge the rechargeable battery in a hot environment (> 60°C).
- ▶ Only charge the rechargeable battery using the supplied mains/power supply device.



For identification purposes, the power supply contains a sticker with the name of the compatible devices. The power supply is designed for the 100 V – 240 V range.

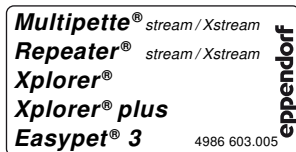

### Procedure for recharging the rechargeable battery

1. Insert the assembled power supply unit into a socket.
2. In the Xplorer pipette check whether a rechargeable battery is inserted and connected.
3. Insert the charging plug of the power supply into the connector socket of the pipette.  
The display briefly shows the connection with the power supply. The charging process is indicated in the display by a flashing rechargeable battery symbol. If the rechargeable battery is almost completely discharged, the display will only switch on after a slight delay.
4. Switch on the pipette to observe the charging process.
5. Charge the rechargeable battery for at least three hours.  
The rechargeable battery will only achieve its full capacity after several discharge/charge cycles.

For storing and charging the single-channel and multi-channel Xplorer pipettes, you can alternatively use a series 4880 charger stand or charger carousel.

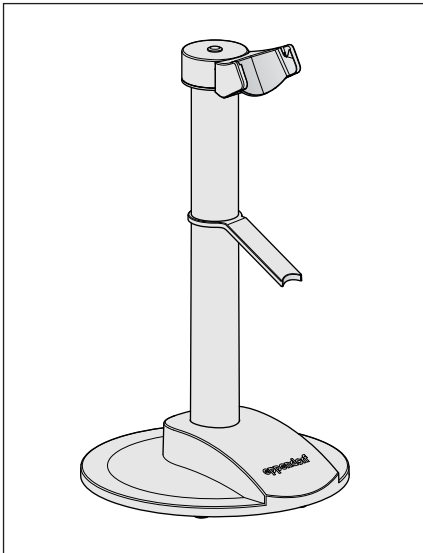

Charger stand 4880

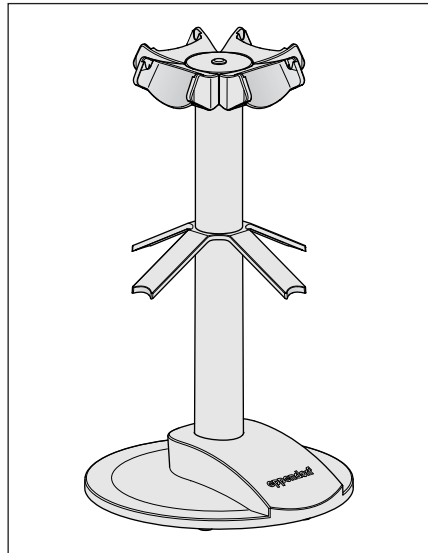

4880 charging carousel

## Operation

Eppendorf Xplorer®/Eppendorf Xplorer® plus  
English (EN)

### 5 Operation

#### 5.1 Switching the pipette on or off



When not in use, the switched on pipette automatically switches to the standby mode after a period of time. The pipette automatically switches back on when it is moved.

##### 5.1.1 Switching on

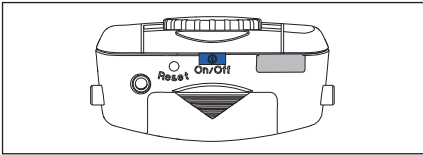

- ▶ Keep the **On/Off** key pressed. The pipette switches itself on.

##### 5.1.2 Switching off

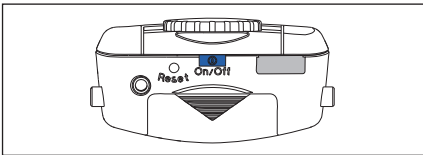

- ▶ Keep the **On/Off** key pressed. The pipette switches itself off.

### 5.2 Setting the *Date* and *Time* (Xplorer plus)

Set the *Date* and *Time* parameters during the initial start-up.

Prerequisites

- The rechargeable battery is connected.
  - The rechargeable battery is charged.
  - The pipette is switched on.
1. Select *Date* or *Time* using the rocker.
  2. Press the *Select* softkey.
  3. Change the value using the rocker.
  4. Press the *Next* softkey to change the field.
  5. Press the *End* softkey to end the entry.
  6. Change the second parameter in the same way.
  7. Press the *End* softkey to end the entry.
  8. Press the rocker down.

The basic position of the piston is checked. The pipette is ready for use afterwards.



### 5.3 Principle of operation

Every pipette is equipped with different operating modes and a primary mode for configuring the pipette. The adjustable parameters and operational procedures differ in the operating modes.

During operation, the piston in the pipette is moved according to how the rocker is actuated. When you press the rocker up, the piston in the pipette moves up. Liquid is aspirated into the attached pipette tip. When you press the rocker down, the piston in the pipette moves down. The liquid in the pipette tip is dispensed.

Press the *Edit* softkey to open the edit mode of the selected operating mode. Here, you can use the rocker to change the parameter that is outlined and marked red.

- 
 Special operating sequences with an electric pipette are possible with dispensing using the rocker. For example, you can cancel a piston movement in the **Dis**, **Pip** and **P/M** modes at any time by pressing the rocker in the other direction. You can cancel the piston movement in the **Ads** and **Man** modes by releasing the depressed rocker. After the piston has been stopped, you can continue the aspiration or dispensing process by pressing the rocker in the corresponding direction.

If the piston is in the basic position, you can repeat the blow-out (*Blow*) at any time by pressing the rocker down.

- 
 The pipette software is available in several languages. To change the language, change the *Language* parameter in the options.

### 5.4 Selecting the operating mode

The following operating modes are available:

Selection dial	Mode	Xplorer	Xplorer plus
<b>Ads</b>	Automatic dispensing Dispensing of partial volumes in a defined interval	■	■
<b>Dis</b>	Dispensing Dispensing of uniform partial volumes	■	■
<b>Pip</b>	Pipetting Aspiration and dispensing of liquid	■	■
<b>P/M</b>	Pipetting and mixing Pipetting with freely selected mixing volume	■	■

**Operation**Eppendorf Xplorer®/Eppendorf Xplorer® plus  
English (EN)

Selection dial	Mode	Xplorer	Xplorer plus
<b>Man</b>	Manual pipetting Aspiration and dispensing when the rocker is held pressed down	■	■
<b>Opt</b>	Options Making settings and changing the adjustment	■	■
<b>Spc</b>	<i>Multiple aspiration</i> Aspiration of uniform partial volumes and combined dispensing (reverse dispensing)	–	■
	<i>Diluting</i> For diluting a sample or reagent	–	■
	<i>Sequential dispensing</i> Functions like dispensing mode with a fixed sequence of various volumes	–	■
	<i>Reverse pipetting</i> Functions like the pipetting mode, but in reverse order (aspiration with blow-out).	–	■
	<i>Sequential pipetting</i> For creating pipetting series with various volumes	–	■
<b>Prg</b>	Program Execute saved dispensings	–	■
<b>Edit</b>	Editing Procedure programs and pipettings with fixed volumes	–	■
<b>Fix</b>	Pipetting with fixed volumes Procedure pipettings with fixed volumes.	–	■

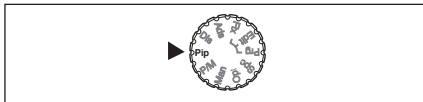

► Sets the operating mode.

## 5.5 Setting the parameters (edit mode)

Prerequisites

- The pipette is switched on.
- The operating mode has been selected.

Change the parameters as follows:

1. Press the *Edit* softkey to open the edit mode.
2. Press the *Next* softkey to go to the next dispensing parameter.
3. Change the dispensing parameter marked in the display using the rocker.
4. Press the *End* softkey to save the changes, to exit the edit mode and to continue with dispensing.

**i** If you want to cancel editing without saving the changes made, briefly turn the selection dial to another mode.

**i** You can change the *Speed*, *Time*, *Cycles* and *Counter* parameters during dispensing.



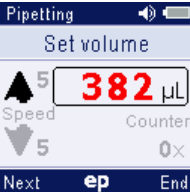
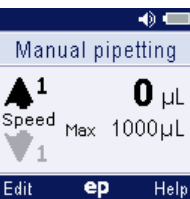

- ▶ Press the *Edit* softkey during execution.









### 5.5.1 Xplorer/Xplorer plus

Display	Parameter	Mode				
		Ads	Dis	Pip	P/M	Man
	<p><i>Set volume</i> Aspiration and dispensing volume.</p>			■	■	
	<p><i>Set max. volume</i> Maximum aspiration and dispensing volume. The set value appears after editing in the display next to <i>Max</i>.</p>					■

## Operation

Eppendorf Xplorer®/Eppendorf Xplorer® plus  
English (EN)

Display	Parameter	Mode				
		Ads	Dis	Pip	P/M	Man
	<p><i>Set volume/step</i> Volume per dispensing step. The maximum number of aspiration steps (<i>Steps</i>) will be displayed when the <i>Set volume/step</i> is changed.</p>	■	■			
	<p><i>Aspiration speed</i> Aspiration speed 8 levels are available. The higher the numerical value, the higher the speed. <i>Aspiration speed</i> will be automatically and approximately used for the blow-out (<i>Blow</i>).</p>	■	■	■	■	■
	<p><i>Dispensing speed</i> Dispensing speed 8 levels are available. The higher the numerical value, the higher the speed. <i>Dispensing speed</i> will be automatically and approximately used for the blow-out (<i>Blow</i>).</p>	■	■	■	■	■
	<p><i>Set time</i> Interval between the dispensing step (0.1 s to 10 s).</p>	■				

Display	Parameter	Mode				
		Ads	Dis	Pip	P/M	Man
 <p>Dispensing  </p> <p>Number of steps</p> <p>▲ 5 50 µL Speed Steps ▼ 5 19x</p> <p>Next ep End</p>	<p><i>Number of steps</i></p> <p>Number of dispensing steps The available number of dispensing steps depends on the setting for <i>Set volume/step</i> and is automatically set to the maximum number when <i>Set volume/step</i> is edited.</p> <p>Under steps <b>1/5</b> in the "Sequential dispensing" mode, the selected number of dispensing steps will be displayed to the right, and the dispensing step for the displayed volume will be shown at the left.</p>	■	■			
 <p>Pipetting  </p> <p>Set counter</p> <p>▲ 7 675 µL Speed Counter ▼ 5 239x</p> <p>Next ep End</p>	<p><i>Set counter</i></p> <p>The counter counts the number of dispensing operations performed. The numerical value of the counter is increased by 1 when the piston reaches the basic position after dispensing. If the piston is in the basic position, you can alternatively set the counter to 0 by turning the selection dial forward or backward. You can switch the counter on and off in the Options.</p>			■		
 <p>Pipetting+Mix  </p> <p>Mixing volume</p> <p>▲ 5 1000 µL Speed Mix 1000 µL ▼ 5 Cycles 5x</p> <p>Next ep End</p>	<p><i>Mixing volume</i></p> <p>The mixing volume used after pipetting. If you change the pipetting volume under <i>Set volume</i>, the mixing volume changes accordingly.</p>				■	

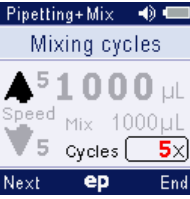

## Operation

Eppendorf Xplorer®/Eppendorf Xplorer® plus  
English (EN)

Display	Parameter	Mode				
		Ads	Dis	Pip	P/M	Man
	<p><i>Mixing cycles</i> 1 to 99 mixing cycles can be set for the mixing volume. The mixing cycles are counted down to 0. If you keep the rocker pressed down during mixing, after 0 has been reached, mixing is continued until the rocker is released. If you press the rocker up during mixing, the mixing process is stopped. The mixing speed matches the selected speed for aspiration and dispensing.</p>				■	

### 5.5.2 Xplorer plus

- The **Spc** operating mode has been selected.

Display	Parameter	Mode	
		Dil	SeqD
	<p><i>Set sample vol.</i> Volume of the sample or reagent The maximum potential diluent volume will be automatically set if the volume of the sample is changed.</p>	■	
	<p><i>Set air volume</i> Volume of the air bubble The maximum potential diluent volume will be automatically set if the volume of the air bubble is changed.</p>	■	

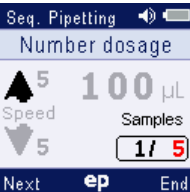
Display	Parameter	Mode	
		Dil	SeqD
	<p><i>Set diluent vol.</i></p> <p>Volume of the dilution solution (diluent) The maximum potential diluent volume will be automatically set if the volume of the sample or the air bubble is changed.</p>	■	
	<p><i>No. dosage</i></p> <p>Number of dispensings performed. A maximum of 10 steps are available. The selected number of dispensings will be shown in red under <i>Samples 1 / 5</i> at the right of the display. The active dispensing step will be activated by the number at the left.</p>		■

## 5.6 Recommended pipette tips

We recommend using epT.I.P.S. epT.I.P.S. pipette tips are available with various degrees of purity, with and without filters, and as special tips.

Pipette tip	Use
ep Dualfilter T.I.P.S	Liquids that require the pipette to be protected from contamination by aerosols.
ep Dualfilter T.I.P.S SealMax	Liquids that require the pipette to be protected from contamination by aerosols and aqueous solutions.
ep T.I.P.S	Liquids without any special risks.
ep.T.I.P.S LoRetention	Liquids whose surface tension is lower than that of water (e.g., due to the presence of a wetting agent in the liquid).

## 5.7 Using pipette tips

The liquid to be dispensed is aspirated into pipette tips.

The pipette can only be used if a pipette tip has been attached. You can either attach the pipette tip by hand or directly insert the end of the pipette into a tip held in the tip storage box (e.g., epT.I.P.S. tray).

- i** The color coding of the pipette matches that of the epT.I.P.S. tray.
- i** If you attach a pipette tip by hand, it must be handled in a way that prevents both the contamination and heating of the pipette tip.

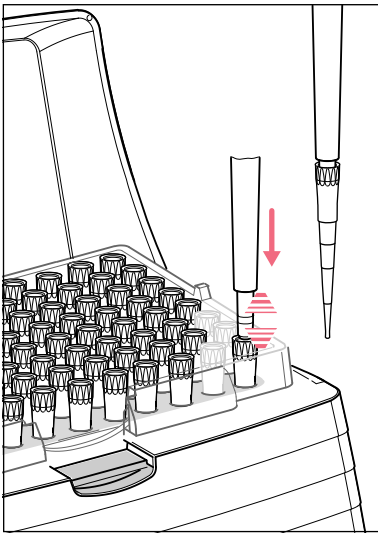

1. Select the appropriate pipette tip(s).
2. Fit the appropriate pipette tip on the tip cone, applying light pressure. The pipette tip is fitted securely when the tip cone responds with spring-loaded action.

- i** You can deactivate the spring-loaded action of the tip cones.
- i** The tip cones on pipette models larger than 1000  $\mu\text{L}$  do not respond with spring-loaded action.
- i** Do not use filter tips if a filter sleeve with protection filter is inserted.

## 5.8 Volume limit in the case of pipette tips with a filter

A filter in the pipette tip reduces the volume of the pipette tip. With some ep Dualfilter T.I.P.S filter tips, the volume of liquid aspirated must be limited in all dispensing modes



and during reverse pipetting (see (see *Volume limit – setting the volume limit on p. 53*))

## 5.9 Tips for correct pipetting

Observe the following information in all dispensing modes:

### 5.9.1 Preparing pipetting

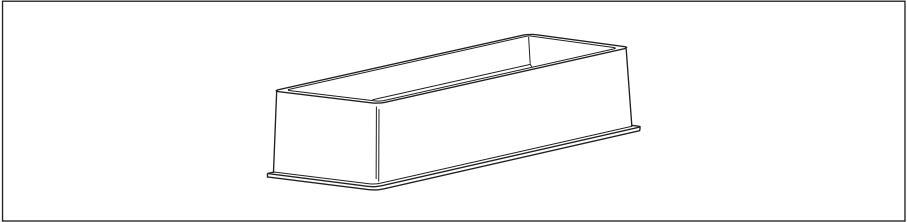

Fig. 5-1: Tip-Tub reagent reservoir

- ▶ Always place the liquid in a suitable tube. For multi-channel pipettes, we recommend the Tip-Tub reagent reservoir as a liquid reservoir. The liquid and the pipette should have approximately the same temperature.
- ▶ Use the pipette tips only once.
- ▶ Use epT.I.P.S. LoRetention for solutions containing surfactants is for minimizing residual moisture in the tip after dispensing.
- ▶ Use ep Dualfilter T.I.P.S. to prevent aerosol contamination in the tip.
- ▶ Check whether the set aspiration and dispensing speeds are suitable for the liquid. The blow-out (Blow) will be conducted at approximately the same speeds.

### 5.9.2 Aspirating liquid



1. Wet the new pipette tip by aspirating and dispensing the liquid to be pipetted one to three times.
2. Vertically immerse the pipette tip into the liquid approx. 4 mm during aspiration.
3. Press the rocker up to aspirate liquid. Maintain the immersion depth to ensure no air is accidentally aspirated.
4. For large volumes, keep the pipette tips in the liquid for approx. 3 seconds after aspiration.
5. After aspiration, slowly pull the pipette tip out of the liquid.
6. Wipe the pipette tip slowly against the tube wall to ensure that no outer wetting remains on the pipette tip.

### 5.9.3 Dispensing liquid

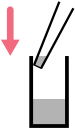

1. When dispensing liquid, place the pipette tip at a slight angle against the wall of the tube.
2. Press the rocker down to dispense the liquid.
3. After dispensing, wait until no more liquid is dispensed.

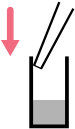

4. Press the rocker down again to trigger the blow-out (Blow).



#### Stopping the piston movement

Pressing the rocker in the other direction when the piston is still moving will stop the piston movement. You can then move the piston either up or down by pressing the rocker in the corresponding direction. Pressing the rocker up will abort a mixing process.

Operating modes with the rocker pressed down: in the **Man** mode, the ongoing piston movement is immediately stopped by releasing the rocker. In the **Ads** mode, an ongoing dispensing step is completed after the rocker is released. The next dispensing step is only performed when the rocker is pressed accordingly.



- Free jet dispensing may be used to dispense aqueous solutions with a volume of approximately 20 µL or more. We recommend wall dispensing for dispensing aqueous solutions with a smaller volume.
- Select level 8 for the *Speed* parameter when using free jet dispensing and if the geometry of the dispensing tube permits this action.
- If you dispense liquid in the free jet, the reverse stroke must also be dispensed in the free jet. If a drop then forms on the pipette tip, it is included in the first dispensing volume.
- For wall dispensing, trigger the reverse stroke with the pipette tips on the tube inner wall.
- During dispensing, do not switch between free jet dispensing and wall dispensing.

**The following information applies especially to high viscous solutions:**

- ▶ During the blow-out (Blow), keep the rocker pressed down if the liquid is flowing out at a slow rate to ensure that the liquid can securely flow out. If you keep the rocker pressed during the blow-out (Blow), the piston in the pipette will remain at its lowest position.
- ▶ Wipe any outer wetting against the wall of the tube while holding the rocker pressed down.
- ▶ Leave the dispensing vessel with the rocker pressed down. The rocker may only be released outside of the dispensing vessel. The piston will only move to its basic position after the rocker has been released.
- ▶ Press the rocker down again to repeat the blow-out (Blow) as necessary.

### 5.10 Automatic dispensing (Ads selection dial setting)

In the *Auto dispensing (Ads)* mode, liquid is aspirated and dispensed in uniform partial volumes in selected time intervals. The reverse stroke and remaining stroke are triggered before or after the dispensing steps.

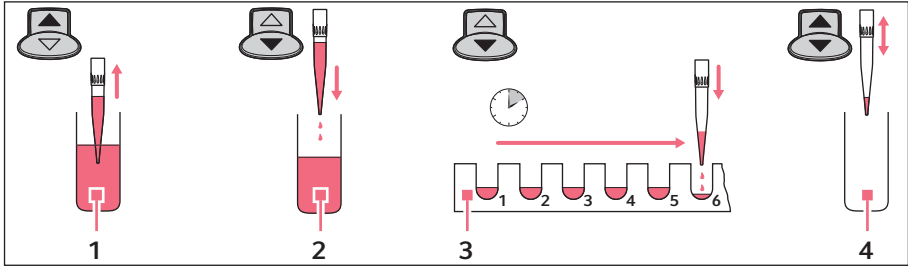

1 **Aspiration**

2 **Reverse stroke**

3 **Auto dispensing**

4 **Aspirate or empty**

#### Prerequisites

- The pipette is switched on.
- The *Auto dispensing (Ads)* operating mode has been selected.
- The parameters have been set.
- The pipette tip has been attached.

1. Press the rocker up to aspirate liquid.  
Then follow the instructions on the display.
2. Press the rocker down to trigger the reverse stroke.
3. Keep the rocker pressed for the duration of dispensing. After the first dispensing step, the following dispensing steps are triggered with the displayed time interval (*Time*).
  - ▶ Press the *Empty* softkey to cancel dispensing. The tip is completely emptied.
  - ▶ When you release the rocker, an ongoing dispensing operation is still completed. The display shows the possible dispensing steps under *Steps*. Press the rocker again to continue dispensing.

After dispensing, decide whether the residual liquid should be dispensed or liquid should be aspirated again.

- ▶ **Liquid aspiration:** press the rocker up once.
- ▶ **Liquid dispensing:** press the rocker down twice.

## 5.11 Dispensing of liquid – Dis selection dial setting

In the *Dispensing (Dis)* mode, liquid is aspirated and individually dispensed in uniform partial volumes. The reverse stroke and remaining stroke are triggered before or after the dispensing steps.

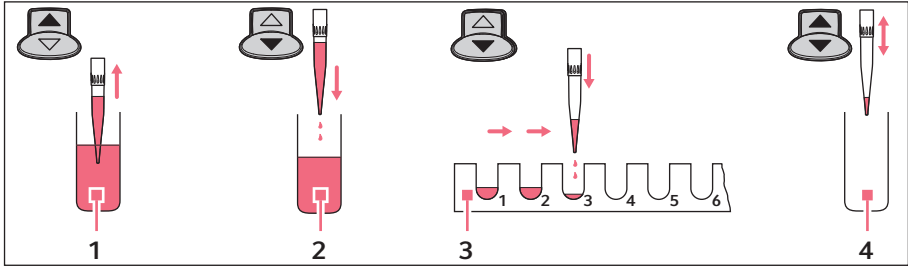

1 **Aspiration**

2 **Reverse stroke**

3 **Dispensing**

4 **Aspirate or empty**

Prerequisites

- The pipette is switched on.
- The *Dispensing (Dis)* operating mode has been selected.
- The parameters have been set.
- The pipette tip has been attached.

1. Press the rocker up to aspirate liquid.
2. Press the rocker down to execute the reverse stroke.
3. Press the rocker down again for each dispensing operation. The display indicates the remaining dispensing steps under *Steps*.

After dispensing, decide whether the residual liquid should be dispensed or liquid should be aspirated again.

▶ **Liquid aspiration:** press the rocker up once.

▶ **Liquid dispensing:** press the rocker down twice.



▶ Press the *Empty* softkey to cancel dispensing. The tip is completely emptied.

▶ Press the rocker up to stop a current dispensing of a large dispensing volume.

## 5.12 Pipetting of liquid – Pip selection dial setting

### 5.12.1 Standard pipetting

In the *Pipetting (Pip)* mode, liquid is aspirated and then dispensed again.

- i** The number of dispensing steps performed can be counted with a counter (*Counter*). The counter (*Counter*) can be activated in the *Option (Opt)* mode, if desired.

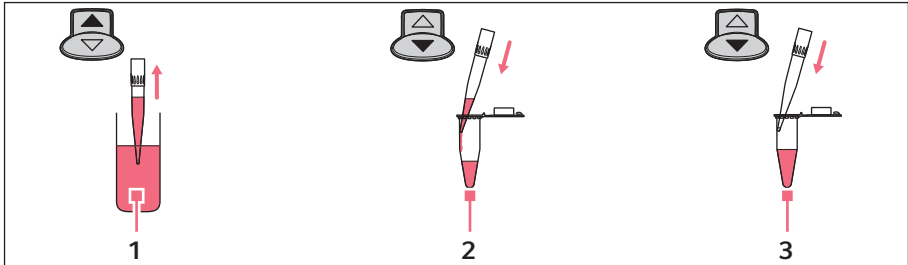

1 **Aspiration**

3 **Blow-out**

2 **Dispensing**

Prerequisites

- The pipette is switched on.
  - The *Pipetting (Pip)* operating mode has been selected.
  - The parameters have been set.
  - The pipette tip has been attached.
1. Press the rocker up to aspirate liquid.
  2. Press the rocker down to dispense the liquid.
  3. Press the rocker down again to dispense the residual liquid.  
This blow-out (Blow) is necessary to completely dispense the liquid.

- i** Hold the rocker pressed down to trigger dispensing and blow-out (Blow) in a step.

- i** If you only hold the rocker pressed down during the blow-out (Blow) after dispensing, the piston remains in the lowest position. The piston will only return to the basic position after the rocker has been released. This presents the following advantages:

  - ▶ If you pipette liquid that drains slowly, you can allow this liquid to flow out.
  - ▶ You can immerse the pipette tip in the target liquid to prevent unintentional aspiration.
  
- i** ▶ You can trigger the blow-out (Blow) any time the piston is in the basic position. Press the rocker down.

▶ Press the rocker in the opposite direction if you would like to stop aspiration or dispensing while it is in progress. The display shows the volume present in the pipette tip after the respective operation has been stopped. You can then continue with liquid aspiration or dispensing.
  
- i** Dispense the liquid against the tube inner wall if you are determining the systematic and random errors.

**Operation**

Eppendorf Xplorer®/Eppendorf Xplorer® plus  
English (EN)

**5.12.2 Reverse pipetting (Xplorer)**

By using the blow-out, more liquid is aspirated with reverse pipetting than with standard pipetting. During dispensing, the blow-out (Blow) does not belong to the dispensing volume. Reverse pipetting is advantageous for plasma, serum and other liquids with a high protein content. Reverse pipetting is not necessary for pipetting aqueous solutions.

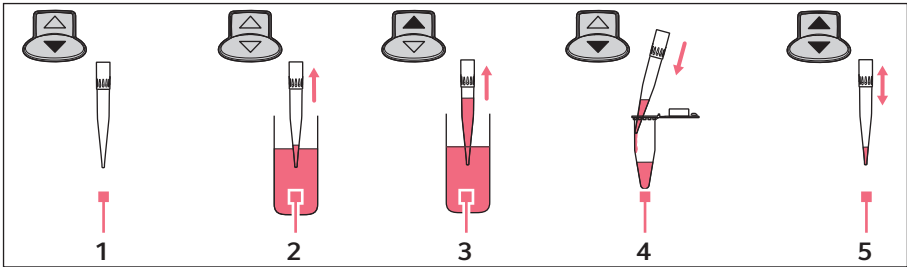

1 Keep the rocker pressed

2 Aspirate the blow-out

3 Aspirate

4 Dispense

5 Aspirate or empty

**Prerequisites**

- The pipette is switched on.
- The *Pipetting (Pip)* operating mode has been selected.
- The parameters have been set.
- The pipette tip has been attached.

1. Keep the rocker pressed down.
2. Immerse the pipette tip in the liquid.
3. Release the rocker to aspirate the blow-out.
4. Press the rocker up to aspirate the dispensing volume.
5. Place the pipette tip on the wall of the target tube.
6. Press the rocker down to dispense the liquid.
7. Remove the pipette tip from the destination tube. Residual liquid remains in the tip. There are two courses of further action:

**Aspirate the same liquid from the same reservoir tube.**

- ▶ Press the rocker up to aspirate the same liquid. The residual liquid in the tip is used for further processing.

**Dispense a different liquid**

1. Press the rocker up to discard the residual liquid in the tip.
  2. Press the ejector to eject the pipette tip.
- Use a new pipette tip for the next dispensing operation.



### 5.13 Pipetting and mixing of liquids – P/M selection dial setting

In the *Pipetting+Mix (P/M)* mode, liquid is aspirated and then dispensed again. Afterwards, an adjustable number of mixing cycles is automatically triggered. The mixing cycles can be continued as often as required.

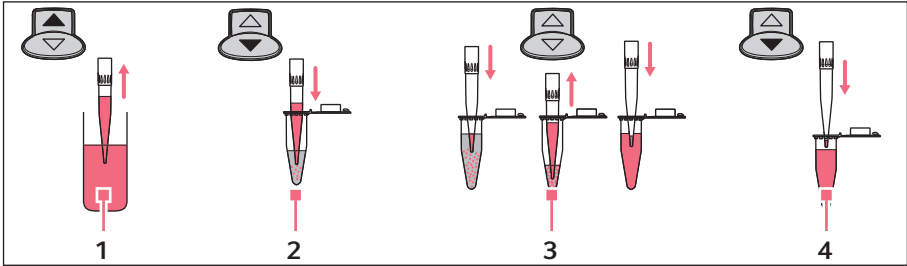

**1 Aspiration**

**2 Dispensing**

**3 Auto mixing**

**4 Blow-out**

#### Prerequisites

- The pipette is switched on.
  - The *Pipetting+Mix (P/M)* operating mode has been selected.
  - The parameters have been set.
  - The pipette tip has been attached.
1. Press the rocker up to aspirate liquid.
  2. Press the rocker down to dispense the liquid and start the selected mixing cycle.  
The mixing cycles shown under *Cycles* in the main field of the display are reduced by 1 with each cycle.
  3. After the mixing process, press the rocker down to trigger the blow-out (Blow).  
If you keep the rocker pressed during the blow-out, the piston moves to the lowest position and remains there until the rocker is released.
- i**
- ▶ Press the rocker down to stop aspiration.
  - ▶ Press the rocker up to stop dispensing or the current mixing cycle.
  - ▶ Hold the rocker pressed down during the mixing cycles to conduct an unlimited number of mixing cycles. The current mixing cycle will still be completed after the rocker has been released.

**Operation**

Eppendorf Xplorer®/Eppendorf Xplorer® plus  
English (EN)

**5.14 Manual pipetting of liquid – Man selection dial setting**

In the *Manual Pipetting (Man)* mode, the pipette is used like a manual dispenser. The maximum aspiration volume can be limited if required. Aspiration can be stopped or continued, or the direction can be changed, as often as required.

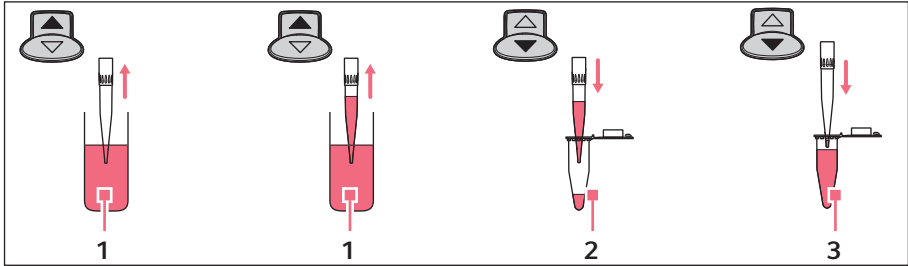
**1 Aspiration****3 Blow-out****2 Dispensing**

You can set a maximum aspiration volume using the *Set max. volume* parameter in the *Option (Opt)* mode. The maximum aspiration volume will be displayed during dispensing (*Max*).

**Prerequisites**

- The pipette is switched on.
  - The *Manual Pipetting (Man)* operating mode has been selected.
  - The parameters have been set.
  - The pipette tip has been attached.
1. To aspirate or dispense liquid, press the rocker up or hold it pressed down. The piston movement stops when the rocker is released. The display shows the liquid volume in the pipette tip.
  2. If the piston is in the basic position, you can trigger the blow-out (Blow) any time by pressing the rocker down. If you keep the rocker pressed during the blow-out (Blow), the piston moves to the lowest position and remains there until the rocker is released.

## 5.15 Special operating modes (Xplorer plus)

If you have never worked with the Xplorer pipette, we recommend becoming familiar with one of the simple operating modes first, e.g., *Pipetting* or *Dispensing*. If you turn the selection dial to the **Spc** dial setting, the special operating modes will be shown in a selection list in the display.

### 5.15.1 Multiple aspiration of liquid (Aspirate) – Spc selection dial setting

A specific volume will be aspirated in the *Multi-Aspirate* mode several times. All of the liquid will be dispensed after the aspiration. The *Multi-Aspirate* mode is the opposite of the dispensing mode.

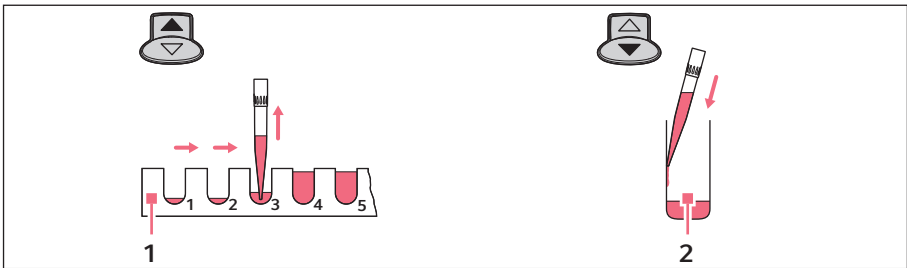

**1 Aspirating partial volumes**

**2 Dispensing**

#### Prerequisites

- The pipette is switched on.
- The *Multi-Aspirate* (**Spc**) operating mode has been selected.
- The parameters have been set.
- The pipette tip has been attached.

**i** The *Set volume/step* parameter determines the volume to be aspirated for each step. The maximum number of aspiration steps (*Steps*) will be displayed when the *Set volume/step* is set.

1. For every aspiration, press the rocker up to aspirate liquid.  
The following message appears on the display after aspiration has been completed:  
*Piston is in top position! Press rocker down!*
2. Press the rocker down to dispense all of the liquid.
3. Press the rocker down again to trigger the blow-out (*Blow*).
4. If the piston is back in the basic position: press the *Back* softkey to exit the mode.

## Operation

Eppendorf Xplorer®/Eppendorf Xplorer® plus  
English (EN)

### 5.15.2 Diluting liquid (Diluting) – Spc selection dial setting

Two different liquids are aspirated in the *Diluting* mode. These liquids are separated by an air bubble. The *Diluting* mode is suitable for diluting samples and reagents using an appropriate dilution solution (diluent). First, the diluent is aspirated, then the air bubble, and finally the sample or reagent.

- i** Because both liquids are aspirated in a single pipette tip, the sample or reagent may be slightly contaminated by the dilution solution.

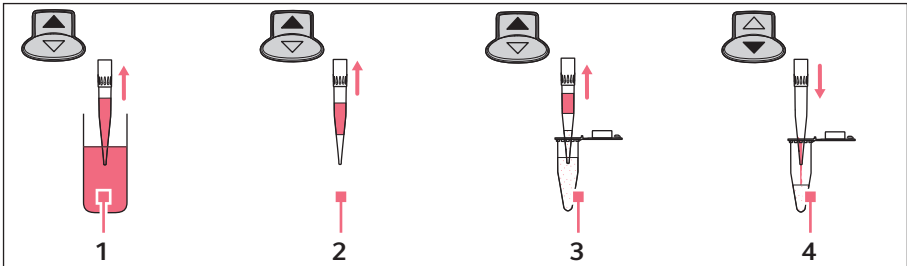

**1** Aspiration of the diluent

**2** Air bubble

**3** Aspiration of the sample or reagent

**4** Dispensing

#### Prerequisites

- The pipette is switched on
- The *Diluting (Spc)* operating mode has been selected.
- The parameters have been set.
- The pipette tip has been attached.

- i** For execution, the parameter sequence is carried out in the reverse order of the editing process. The next volume to be aspirated will be shown on the display with a border around it.

1. Press the rocker up to aspirate the diluent.
2. Press the rocker up to aspirate the air bubble.
3. Press the rocker up to aspirate the sample or reagent.
4. Press the rocker down to dispense all of the liquid.
5. Press the rocker down to trigger the blow-out *Blow*.
6. If the piston is in the basic position: press the *Back* softkey to exit the mode.

- i** Set a high value for the *Dispensing speed* parameter to achieve a good mixture for dispensing.

- i** To achieve a very high mixture, you can enter the *Diluting* mode with the *Pipetting+Mix* mode as the program.

### 5.15.2.1 Examples:

Required auxiliary aids:

- Xplorer plus with a nominal volume of 1000  $\mu\text{L}$
- Dispensing tube (1.5 mL)

#### **Example 1 - total volume 500 $\mu\text{L}$ , dilution 1:10**

- Diluent: 450  $\mu\text{L}$
- Air bubble: 300  $\mu\text{L}$  - 500  $\mu\text{L}$
- Sample or reagent: 50  $\mu\text{L}$

#### **Example 2 - total volume 900 $\mu\text{L}$ , dilution 1:10**

- Diluent: 810  $\mu\text{L}$
- Air bubble: 100  $\mu\text{L}$
- Sample or reagent: 90  $\mu\text{L}$

#### **Example 3 – total volume 1000 $\mu\text{L}$ , dilution 1:10**

- Diluent: 900  $\mu\text{L}$
- Air bubble: 0  $\mu\text{L}$
- Sample or reagent: 100  $\mu\text{L}$

### 5.15.3 Sequential dispensing of liquid – Spc selection dial setting

Up to 10 different volumes can be dispensed in the *Seq. Dispensing* mode. The sum of the dispensing volumes may not exceed the pipette tip filling volume. This mode is well suited for dilution series. The *Seq. Pipetting* mode is also well suited for dilution series. To conduct a dilution series, dispense two different liquids in the opposite direction. This allows you to achieve different dilutions with the same volume per tube.



If the sum of the dispensing volumes exceeds the volume of the pipette tip: create a program and execute the mode several times in a row.

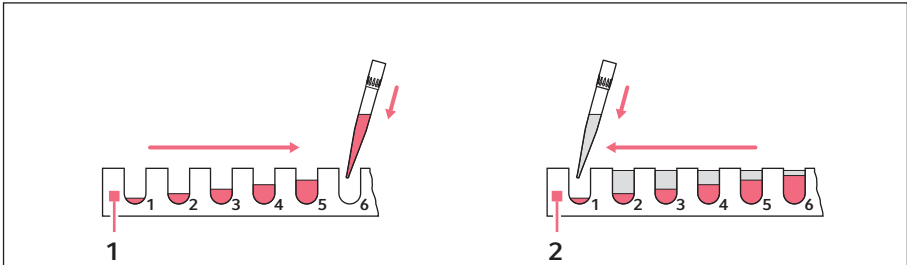

1 Sequential dispensing of solution 1

2 Sequential dispensing of solution 2 in the opposite direction

#### Prerequisites

- The pipette is switched on.
  - The *Seq. Dispensing (Spc)* operating mode has been selected.
  - The parameters have been set
  - The pipette tip has been attached.
1. Press the rocker up to aspirate liquid.
  2. Press the rocker down to execute the reverse stroke.
  3. Press the rocker down for each dispensing step.
  4. If the piston is in the basic position: press the *Back* softkey to exit the mode.

### 5.15.3.1 Example

Required auxiliary aids:

- Xplorer plus with a nominal volume of 300 µL
- 4 dispensing tubes (200 µL)

	Tube 1	Tube 2	Tube 3	Tube 4
Volume/step →	30 µL	60 µL	90 µL	120 µL
Volume/step ←	120 µL	90 µL	60 µL	30 µL
Dilution 1+X	1+4	1+1.5	1+0.67	1+0.25
Dilution 1:Y	1:5	1:2.5	1:1.67	1:1.25
Tube total	150 µL	150 µL	150 µL	150 µL

### 5.15.4 Reverse pipetting of liquid – Spc selection dial setting

The *Rev. Pipetting* mode is well suited for plasma, serums and other liquids with a high protein content. The *Pipetting* mode is also well suited for aqueous solutions. The *Rev. Pipetting* mode is also well suited for solutions containing wetting agents in order to minimize the formation of foam during dispensing in the target tube. The liquid is aspirated using blow-out (*Blow*). The blow-out is not part of the dispensing volume and may not be dispensed into the target tube. If you use the same liquid again, the blow-out may remain in the tip. If you use a different liquid, discard the blow-out and the pipette tip.

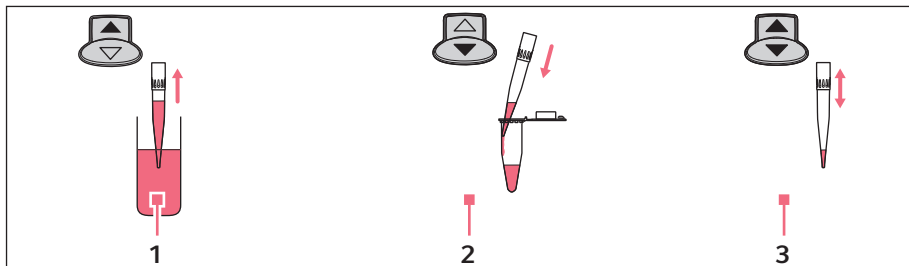

1 Aspiration

3 Aspirate or empty

2 Dispensing

Prerequisites

- The pipette is switched on.
- The *Rev. Pipetting (Spc)* operating mode has been selected.
- The parameters have been set.
- The pipette tip has been attached.

**Operation**

Eppendorf Xplorer®/Eppendorf Xplorer® plus  
English (EN)

1. Press the rocker up to aspirate the blow-out and the liquid to be dispensed.  
The aspiration of the dispensing volume and blow-out will be displayed under the dispensing volume with the label + *Blow* ▲.
2. Press the rocker down to dispense the liquid.  
The piston returns to the basic position. Liquid remains in the tip after the dispensing volume has been dispensed.
  - Press the rocker up to aspirate the same liquid.
  - Press the rocker down to end the pipetting and discard the blow-out (*Blow*).



If necessary, activate the *Counter* setting in the options to count the executed dispensings using the pedometer.

### 5.15.5 Sequential pipetting of liquid – Spc selection dial setting

In the *Seq. Pipetting* mode, a maximum of 10 different pipetting volumes are dispensed in a fixed sequence. This mode is well suited for dilution series. The *Seq. Dispensing* mode is also well suited for dilution series. The random error (precision) and systematic error (accuracy) are better for pipetting than with dispensing. The *Seq. Pipetting* mode offers more flexibility with the volume selection than the *Seq. Dispensing* mode.

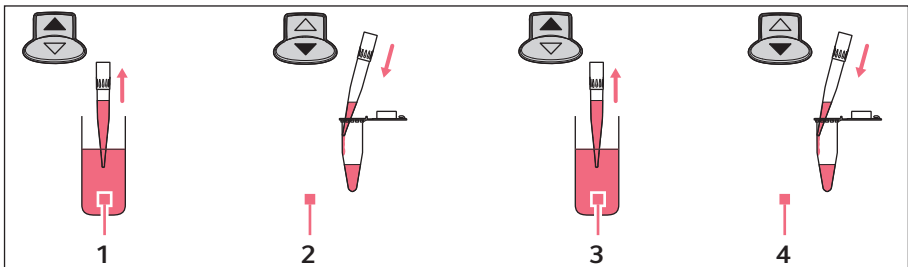

1 **Aspiration**

2 **Dispensing**

3 **Aspiration**

4 **Dispensing**

#### Prerequisites

- The pipette is switched on.
  - The *Seq. Pipetting* (**Spc**) operating mode has been selected.
  - The parameters have been set.
  - The pipette tip has been attached.
1. Press the rocker up to aspirate liquid.
  2. Press the rocker down to dispense the liquid.
  3. Press the rocker downward after the dispensing to execute the blow-out (*Blow*).
  4. If the piston is in the basic position: press the *Back* softkey to exit the mode.



- 
  - ▶ After each dispensing, you can repeat the blow-out (*Blow*) as many times as you would like by pressing the rocker down.
  - ▶ Observe the information on the blow-out (*Blow*).

### 5.16 Executing the saved program – Prg selection dial setting (Xplorer plus)

Previously stored programs can be executed in the *Program* (**Prg**) operating mode. Programs consist of 1-4 combined operating modes in a defined sequence. Up to 10 different programs can be created.

Prerequisites

- The pipette is switched on.
- The *Program* (**Prg**) operating mode has been selected.
- The program has been created.
- The pipette tip has been attached.

1. Select the program using the rocker.
2. Press the *Select* softkey.  
The execution of the program depends on the operating modes used.

- 
  - The blow-out (*Blow*) must always be executed in the "Pipetting" mode.

### 5.17 Editing the program – Edit selection dial setting (Xplorer plus)

Programs and pipettings with fixed volumes can be created and edited in the *Edit* mode. Stored programs can be executed in the *Program* (**Prg**) mode. Stored programs with fixed volumes can be stored in the *Fixed volumes* (**Fix**) mode. If necessary, programs and pipettings with fixed volumes can be password protected using the *Pswrd. protection* option.

Prerequisites

- The pipette is switched on.
- The **Edit** operating mode has been selected.

1. Select the desired list entry using the rocker.
2. Press the *Select* softkey.  
The next steps are described in the following subchapters.

**Operation**

Eppendorf Xplorer®/Eppendorf Xplorer® plus  
English (EN)

**5.17.1 Pswrd. protection**

You can protect the *Edit* mode using a four-digit, numerical password. This prevents stored programs and pipettings from being changed. The passwords for the *Edit* mode and *Adjustment* option may vary. The password can be changed or deactivated after it has been entered. If you lose your password, please contact your local Eppendorf distribution partner to obtain a temporary password (*Master key*). Keep the pipette at hand when you make the call.



If you lose the password for the *Edit* mode, you will not be able to change any programs or pipettings with fixed volume.

1. Press the rocker upward to activate the password protection.  
*ON* appears in the display.
2. Press the *Select* softkey.
3. Use the rocker to select the digit.
4. Press the *Next* softkey to switch to the next field.
5. Enter data in all of the fields.
6. Press the *Save* softkey to save the password.
7. Reenter the password after completing the saving procedure. Press the *Enter* softkey.  
Password protection is now active.

**5.17.2 Creating or changing *Fixed volume*****Creating a new pipetting**

1. Select the *New fixed volume* entry using the rocker.  
The parameters of the most recently used pipetting will be displayed when the *New fixed volume* entry is opened. Up to 10 fixed volumes can be saved.
2. Press the *Edit* softkey.
3. Change the parameters as you did in the *Pipetting* mode.
4. Press the *Save* softkey.  
The saved pipetting now appears in the *Fixed volumes (Fix)* operating mode with dispensing volume, aspiration speed and dispensing speed.

**Changing saved pipettings**

1. Select the pipetting using the rocker.
2. Press the *Select* softkey.
3. Select the *Edit* option.
4. Press the *Select* softkey.

### 5.17.3 Creating or changing *Program*

#### Creating a new program

1. Select the *New program* entry using the rocker. Up to 10 programs can be saved. You will be prompted to name the program. You can enter a name with a maximum of six characters.
  -  The program name cannot be changed later. Copy the program to change the name. You will be prompted to enter a new name. Then delete the original program.
2. Select the characters using the rocker.
3. Press the *Next* softkey to switch to the next field.
4. Press the *Save* softkey to save the name.
5. Select the first operating mode. All operating modes except *Manual Pipetting* are available.
6. Press the *Edit* softkey.
7. Change the parameters of the mode as usual.
8. Press the *Save* softkey.
  - A list with all of the previously saved program modes appears.
    - Press the *Next* softkey to add another mode. A program can contain up to 4 modes.
    - Press the *Save* softkey to save the program. The saved program now appears in the *Program (Prg)* operating mode.

#### Changing the saved program

##### Prerequisites

To change the mode of a program, the program needs to be saved first.

1. Select a saved program from the list.
2. Press the *Select* softkey.
  -  Select the *Copy* option to create a program based on another program. You must then enter a name for the copied program. If you only want to change the name of a program, select the *Copy* option.
3. Select the *Edit* option.
4. Press the *Select* softkey.
  - Select the *Edit mode* option to change a program mode.
  - Select the *Insert mode* option to add a mode to the program.
  - Select the *Delete mode* option to delete a program mode.

### 5.18 Pipetting with fixed volume – Fix selection dial setting (Xplorer plus)

Previously stored programs with fixed volumes can be executed in the *Fixed volumes (Fix)* mode. Up to 10 different pipettings can be created. 3 fixed volumes are predefined upon delivery:

- 10% of the nominal volume
- 50% of the nominal volume
- 100% of the nominal volume

The aspiration speed ▲ and dispensing speed ▼ are displayed to the right of the fixed volume.

Prerequisites

- The pipette is switched on.
  - The *Fixed volumes (Fix)* operating mode has been selected.
  - Pipetting with fixed volume has been created.
  - The pipette tip has been attached.
1. Select the pipetting using the rocker.
  2. Press the *Select* softkey.
  3. Press the rocker up to aspirate liquid.
  4. Press the rocker down to dispense the liquid.
  5. Press the rocker downward after the dispensing to execute the blow-out (*Blow*).

### 5.19 Option – Opt selection dial setting

You can set the following options, which apply to all operating modes in the *Option* mode.

Options:

- *General help*
- *Volume limit*
- *Counter*
- *Ejector reset*
- *Rocker setting*
- *History*
- *Sound level*
- *Brightness*
- *Adjustment*
- *Language*
- *Personalization*
- *Service*
- *Service interval*
- *Date/Time*

#### Prerequisites

- The pipette is switched on.
  - The *Option* operating mode has been selected.
1. Select the list entry using the rocker.
  2. Press the *Select* softkey to open the list entry.
  3. Change the list entry using the rocker.
  4. Press the *End* or *Back* softkey to exit the list entry.
  5. Turn the selection dial to a different operating mode to exit the *Option* function and to continue with dispensing operations.
    - ▶ Press the *Help* softkey to display information on the selected option.



#### 5.19.1 *General help* – calling a description of the modes

This describes the elementary steps for all modes. This option does not contain any adjustable parameters.

#### 5.19.2 *Volume limit* – setting the volume limit

This limits the aspiration volume in all dispensing modes.



After a volume limit has been set, a note will be shown on the display when the **Pip**, **P/M** and **Man** operating modes are edited and when the volume limit has been reached. In this mode, too large dispensing volumes will be automatically reduced to the defined volume limit. The number of potential dispensing steps will be automatically limited in the **Dis** and **Ads** modes. If the corresponding volume is above the defined volume limit, saved dispensings can no longer be executed under *History* and under the **Spc**, **Prg** and **Fix** modes. The volume can be changed in the corresponding mode or the **Edit** mode.

Use the volume limit in the following cases:

- For strongly foaming solutions in order to prevent contamination of the tip cone or the protection filter.
- For pipette tips or filter tips whose aspiration volume is smaller than the nominal volume of the pipette.
- When using ep Dualfilter T.I.P.S. in the **Ads**, **Dis** and **Pip** (reverse pipetting) modes and the Xplorer plus *Rev. Pipetting* mode. For these three versions, there is a risk of the liquid coming into contact with the dualfilter because of the additional volumes during aspiration.

**Operation**

Eppendorf Xplorer®/Eppendorf Xplorer® plus  
English (EN)

ep Dualfilter T.I.P.S.	Volume limit	
	Ads/Dis	Reverse pipetting
10 µL	–	–
100 µL	–	–
200 µL	–	–
300 µL	270 µL	260 µL
1000 µL	–	950 µL
1250 µL Long*	–	1130 µL
5 mL	4.9 mL	4.6 mL**
5 mL Long*	–	–
10 mL*	9.75 mL	8.5 mL**

\* When using these filter tips we recommend to use the adjustment *epTIPS long* in order to increase the accuracy of dispensing. The volume limit stated applies only to the changed adjustment.

\*\* We recommend this volume limit even when performing reverse pipetting and using the 5 mL and 10 mL epT.I.P.S. without a filter.

Other volume limits may apply when using filter tips from other manufacturers. The volume limit differs depending on the tip geometry and the position of the filter in the tip.

The volume limit is dependent on the additional aspirated volumes of the pipette. On the Xplorer the individual nominal volumes result in different additional volumes.

Xplorer Single-channel and multi-channel	Additional aspiration volumes	
	Ads/Dis	Reverse pipetting
10 µL	Approx. 0.6 µL	Approx. 2 µL
100 µL	Approx. 7 µL	Approx. 20 µL
300 µL	Approx. 20 µL	Approx. 60 µL
1000 µL	Approx. 65 µL	Approx. 200 µL
1200 µL	Approx. 140 µL	Approx. 220 µL
5 mL	Approx. 0.3 mL	Approx. 1 mL
10 mL	Approx. 0.55 mL	Approx. 1.8 mL

### 5.19.3 Counter – switching the counter for dispensing steps on/off

The counter provides information on the dispensing operations performed in the **Pip** mode. You can switch the counter on and off using the rocker. After you select the **Pip** mode, an activated counter shows 0. The value can be changed in the **Pip** mode.

### 5.19.4 Ejector reset labware

The *Ejector reset* option has two settings:

- *ON* (default setting) – the piston automatically moves to the basic position even when a filled pipette tip is ejected.
- *OFF* – the piston does **not** automatically move to the basic position.



#### **CAUTION! Unintended dispensing when the *Ejector reset* option is activated.**

- ▶ When working with a removed ejector sleeve, set the *Ejector reset* option to *OFF* to prevent unintentional dispensing from the pipette tip in case the ejector is accidentally pressed.
- 

### 5.19.5 Rocker setting – setting the speed of the rocker

The change speed of the volume in the editing mode can be adjusted to suit your needs. 8 levels are available (1 = slow, 8 = very fast). Level 5 is set upon delivery.

### 5.19.6 History – saving and displaying dispensing settings

If you activate the *History* option, the *History* softkey will be activated instead of the *Help* softkey for most of the operating modes. The last 10 dispensing settings of the active mode can be accessed using the *History* softkey. The dispensing steps appear in chronological order. Dispensing settings will only be stored if the *History* option is activated.

### 5.19.7 Setting the *Sound level*

You can change the sound volume of the acoustic signals. At 0 volume, the sound is switched off and the  symbol will not be displayed.

### 5.19.8 Setting the *Brightness* (display)

The display brightness can be adjusted to suit your needs.

### 5.19.9 Setting the *Adjustment*

The piston stroke of the Xplorer pipettes can be changed by the user in the *Adjustment* option. Instead of the "factory settings" adjustment, you can select a different adjustment. Instructions on performing the adjustment can be found in the document *Adjustment* on our webpage [www.eppendorf.com/manuals](http://www.eppendorf.com/manuals).



- ▶ Making an adjustment sets the dispensing volume in such a way that systematic error is minimized for the intended application. Carry out a gravimetric test of the adjustment.
- ▶ Every pipette whose adjustment has been changed must be marked with a clearly visible label that indicates the type of change made. This ensures that other users will be informed of the changes to the adjustment, in addition to the information provided in the header of the display.
- ▶ You can overwrite a selected adjustment by selecting another adjustment. The applicable symbols for the new adjustment will be shown in the display header.
- ▶ For the Xplorer plus, the adjustment can be protected with a password.

If a different adjustment has been selected instead of factory settings, the display header shows the symbol  and at least another symbol. Before changing an adjustment, make sure to read the chapter "Display" and the document "Adjustment" [www.eppendorf.com/manuals](http://www.eppendorf.com/manuals).

The following adjustments can be selected:

- *Factory settings*  
Resets the adjustment to the factory setting. The factory settings cannot be changed.
- Liquid type: *Ethanol 75%*  
The factory setting is changed by a factor in order to allow 75% ethanol to be dispensed with higher accuracy. The internally used factor takes into account the density and the following work technique in the **Pip** mode:
  1. Wet the tip with liquid three times at room temperature. Hold the pipette vertically during this time. Avoid outer wetting during dispensing.
  2. Use speed level 5 for aspiration and dispensing.
  3. Dispense liquid against the tube wall of the destination tube.
  4. Trigger a blow-out (Blow) approx. 2 seconds after dispensing. Then eject the pipette tip.
- Liquid type: *Glycerol 50%*  
The factory setting is changed by a factor in order to allow 50% glycerol to be dispensed with higher accuracy. The internally used factor takes into account the density of the 50% glycerol and the same work technique as described previously for *Ethanol 75%* in the **Pip** mode.



- *epTIPS long*

In addition to the "standard tips", a second longer tip is available for most pipettes. When *epTIPS long* is selected, the tip geometry of this longer tip is taken into account in the internal volume calculation. This reduces the systematic error of dispensing when using these tips.

Xplorer Nominal volume Volume range	Color code Xplorer rocker	epTIPS long adjustment is valid for		
		Color code epT.I.P.S.	Type epT.I.P.S.	Length epT.I.P.S.
10 µL 0.5 – 10 µL	medium gray	light gray	20 µL Long	46 mm
100 µL 5 – 100 µL	yellow	orange	300 µL	55 mm
1000 µL 50 – 1000 µL	blue	dark green	1250 µL Long	103 mm
1200 µL 50 – 1200 µL	green	dark green	1250 µL Long	103 mm
5 mL 0.2 – 5 mL	violet	violet	5 mL Long	175 mm
10 mL 0.5 – 10 mL	turquoise	turquoise	10 mL Long	243 mm

The epT.I.P.S. specified here are also available as ep Dualfilter T.I.P.S.

- *Altitude*

The aspiration volume of a piston-stroke pipette is reduced at increased altitudes, which entail a fall in air pressure. The average air pressure at the corresponding height is used to correct the stroke. The altitude can be selected in 250 m (820 ft) increments. The maximum selectable height is 5000 m.

The pipette is set to an altitude of 0 m upon delivery. This is the factory setting.



The liquid type (*Ethanol 75% or Glycerol 50%*), *epTIPS long* and *Altitude* options can be combined.

For the following adjustments, you must know the exact density of the solution to be dispensed. The recording of the weighing results requires the use of a fine balance with a high resolution. Dispensing volumes below 10 µL require a balance with a resolution of 0.001 mg. An existing 1-3 point adjustment can be changed.

- *1-point adjust.*

After you input the density, the selected volume and the corresponding weighing result, the pipette will determine a correction factor. The factor is only correct for the selected volume and the selected work technique. However, the factor is used for the entire volume range of the pipette. You must carry out a gravimetric test to check the validity of the factor.

- *2-point adjust.*

After you input the density, two different volumes and the corresponding weighing result, the pipette will determine a correction factor. The factor is only correct for the selected volume range and the selected work technique. However, the factor is used for the entire volume range of the pipette, i.e., below and above the two measuring points as well. You must carry out a gravimetric test to check the validity of the factor.

- *3-point adjust.*

After you input the density, three different volumes and the corresponding weighing results, the pipette will determine two correction factors. The factors are correct from measuring point to measuring point in the selected volume regions and for the selected work technique. The respective factor is, however, also used below and above the first or third measuring point. You must carry out a gravimetric test to check the validity of the factors.



If an adjustment other than factory settings is applied, a gravimetric test of the pipette must be carried out first. This is the only way to ensure that the selected adjustment meets requirements regarding errors.

### 5.19.9.1 Activating the *Pswrd. protection (Xplorer plus)*

You can protect the adjustment using a four-digit, numerical password. The password for the *Edit* mode and the *Adjustment* option can vary. The password can be changed or deactivated after it has been entered. If you lose your password, please contact your local Eppendorf distribution partner or reset the pipette to the factory settings.



The adjustment can no longer be changed if the password has been lost.

1. Press the rocker upward to activate the password protection.  
*ON* appears in the display.
2. Press the *Select* softkey.
3. Use the rocker to select the digit.
4. Press the *Next* softkey to switch to the next field.
5. Enter data in all of the fields.
6. Press the *Save* softkey to save the password.
7. Reenter the password after completing the saving procedure.
8. Press the *Enter* softkey.

Password protection is active.

### 5.19.10 *Language* – setting the language

- ▶ Mark a language in the selection list using the rocker.  
The selected language is only activated after the completion of the language selection.
- ❗ When selecting a language, the softkeys and the language selection list are always in English. This makes it easier to return to the desired language if you select an unknown language by mistake.

### 5.19.11 *Personalization* – personalizing the pipette

You can use the rocker to select letters and numbers to personalize the pipette. The selected personalization will be displayed after the pipette has been activated from sleep mode or after the reset. When the pipette is delivered, it is personalized as *My Xplorer*.

### 5.19.12 *Service* – calling up service functions

The options listed here are not needed during normal routine use.

A selection list offers the following service options:

- *Software version*: Displays the current software version.
- *Parameter ver.:* Displays the applicable data record for this pipette. The data record is different for the various volumes.
- *Initial reset*: After a security query, the pipette will be reset to factory settings and all entries will be reset to the "default values". This type of reset may be useful when transferring the pipette to another workstation.
- *Check procedure*: For service personnel only.
- *Software update*: For service personnel only.
- *USB*: For service personnel only.

### 5.19.13 Activating the *Service interval* (Xplorer plus)

If the *Service interval* option is activated, the pipette will remind you about the required maintenance or repeating the gravimetric test. You can set the reminder for a specific time or after a specific number of cycles.

The display shows the following options after *Time interval* or *Cycles interval* has been selected:

- *Last service*
- *Next service*
- *Set interval*
- *Reset*

For the *Set interval* parameter, set the required interval. If you do not want to use the *Service interval* option, set the value of the parameter to 0. Triggering the reset function resets the interval. If the pipette should start counting at a specific initial value, enter the value under *Set interval* and then select *Reset*. You can view the last time a reset was triggered for the executed maintenance under *Last service*. You can view when the next maintenance needs to be executed under *Next service*. If the interval has elapsed up to 90%, the pipette shows the next required maintenance in the display. Monitoring of the interval time and the interval cycles function independently of each other. If you activate the interval time and interval cycles, you will receive a maintenance reminder for both settings. A reset may be required after the maintenance and the gravimetric test.

#### 5.19.14 Setting the *Date* and *Time* (Xplorer plus)

Prerequisites

- The pipette is switched on.
- The **Opt** operating mode has been selected.
- The pipette is switched on.
  - ▶ Select *Date* or *Time* using the rocker.
  - ▶ Press the *Select* softkey.
  - ▶ Change the value using the rocker.
  - ▶ Press the *Next* softkey to change the field.
  - ▶ Press the *End* softkey to end the entry.
  - ▶ Change the second parameter in the same way.
  - ▶ Press the *End* softkey to end the entry.

#### 5.20 Resetting the pipette to the factory setting

All settings (language, selected parameters, options, etc.) of the pipette are reset to their initial state. All the saved program and adjustment settings are deleted.

The *Initial reset* function also overwrites existing password protection.

##### 5.20.1 Performing *Initial reset* – Opt selection dial setting

Prerequisites

- The pipette is switched on.
  - The *Option* operating mode has been selected.
1. Select *Service* from the list.
  2. Select *Initial reset* from the list.
  3. Confirm the confirmation prompt.
    - The pipette is reset to its initial state.

**6 Troubleshooting**  
**6.1 Reset**

The pipette will be reset to the initial state during the reset. The settings you have saved are retained.

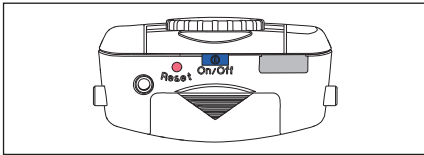

- ▶ Press the **Reset** key using a pipette tip or another pointed object.  
The personalization and software version will be shown in the display during the reset.

**i** You will be prompted to press the rocker down in the display. Make sure that any liquid in the pipette tip is dispensed correctly. Then, you need to confirm the *Date and Time*.

**6.2 Error search**  
**6.2.1 Rechargeable battery**

Symptom/Message	Possible cause	Remedy
<p>The screenshot shows a blue header with 'Battery state' and a speaker icon. Below it, a red exclamation mark is next to 'Battery empty!'. The text continues: 'Confirm with OK!', 'Connect power supply immediately!'. At the bottom, there are 'OK' buttons on either side of the 'ep' logo.</p>	<ul style="list-style-type: none"> <li>• The rechargeable battery is heavily discharged.</li> </ul>	<ul style="list-style-type: none"> <li>▶ Confirm the message with the <i>OK</i> softkey.</li> <li>▶ Complete the dispensing operation as quickly as possible. You can continue dispensing with the power supply connected. Then charge for an additional 3 hours.</li> <li>▶ Charge the rechargeable battery for 3 hours.</li> </ul>
<p>The screenshot shows a blue header with 'Battery state' and a speaker icon. Below it, a red exclamation mark is next to 'Battery empty!'. The text continues: 'Usage not possible! 3 hours charging time!'. At the bottom, there is an 'ep' logo.</p>	<ul style="list-style-type: none"> <li>• The rechargeable battery is almost completely discharged. The remaining rechargeable battery capacity is only sufficient for displaying the information on the display.</li> </ul>	<ul style="list-style-type: none"> <li>▶ Charge the rechargeable battery for at least 15 minutes.</li> <li>▶ Charge the rechargeable battery for 3 hours.</li> </ul>

### 6.2.2 Display

Symptom/Message	Possible cause	Remedy
The display is dark.	• The pipette is switched off.	▶ Switch on the pipette.
	• The rechargeable battery is not connected.	▶ Connect the rechargeable battery.
	• The rechargeable battery is discharged.	▶ Charge the rechargeable battery. <b>Note:</b> If the rechargeable battery is almost completely discharged, the display will only switch on after a short charging time.
	• The battery is defective.	▶ Replace the battery.
Display shows the  symbol.	• The pipette has been adjusted for a different liquid.	▶ Check whether the adjustment selected in the options is correct and change it if necessary.

### 6.2.3 Liquid

Symptom/Message	Possible cause	Remedy
Liquid is dripping from the tip and/or the dispensed volume is incorrect.	• The pipette tip is loose or does not fit correctly.	▶ Attach the tip firmly. ▶ Use epT.I.P.S.
	• Liquid with high vapor pressure and/or different density.	▶ Wet the tip multiple times. ▶ Adjust the pipette for the liquid used.
	• Pipetting was too quick.	▶ Set a lower speed.
	• The tip was withdrawn from the liquid too early or too quickly.	▶ Withdraw the tip from the liquid slowly and with a time delay (of about 3 seconds for large volumes) after aspiration.
	• Liquid dispensed without blow-out (Blow) in <b>Pip</b> mode.	▶ Trigger blow-out (Blow) after dispensing has been completed during standard pipetting applications.
	• The piston is contaminated.	▶ Clean and lightly lubricate the piston.
	• The piston is damaged.	▶ Replace the piston.
	• The tip cone is damaged.	▶ Replace the lower part or channel.
Liquid flows unevenly into or out of the tip.	• The O-rings of the tip cones are damaged.	▶ Replace the O-rings (only 100 µL, 300 µL, 1200 µL multi-channel).
	• The piston is contaminated. • The tip is damaged • The seal is dirty. • The pipette is blocked.	▶ Clean and lightly lubricate the piston. ▶ Use a new tip. ▶ Clean the lower part. ▶ Replace the protection filter (for 5 mL and 10 mL).
The following message appears briefly before the aspiration: <i>Selected volume not possible with stored adjustment!</i>	• A factor that was determined during adjustment leads to a very high stroke increase. This high stroke increase limits the dispensing volume.	▶ Confirm the error message with the <b>OK</b> softkey. The situation can only be remedied by changing the adjustment.  ▶ Make sure that you are authorized to carry out the adjustment.

## Troubleshooting

Eppendorf Xplorer®/Eppendorf Xplorer® plus  
English (EN)

### 6.2.4 Pipette

Symptom/Message	Possible cause	Remedy
No spring-loaded action of the tip cone when taking up pipette tips.	<ul style="list-style-type: none"> <li>The spring-loaded action is blocked.</li> </ul>	<ul style="list-style-type: none"> <li>Single-channel pipette: Remove locking ring.</li> <li>Multi-channel pipette: Remove locking clip.</li> </ul>
	<ul style="list-style-type: none"> <li>The use of a pipette larger than 1000 µL.</li> </ul>	<ul style="list-style-type: none"> <li>No remedy available. The tip cones of pipette models larger than 1000 µL do not respond with spring-loaded action.</li> </ul>
The following message appears briefly for the selected volume: <i>Volume limit</i> XXXX µL/mL	<ul style="list-style-type: none"> <li>The <i>Volume limit</i> option was used to limit the volume to the displayed value.</li> </ul>	<ol style="list-style-type: none"> <li>Make sure that you are authorized to change the <i>Volume limit</i> option.</li> <li>Move the selection dial to <b>Opt</b>.</li> <li>Select the <i>Volume limit</i> option.</li> </ol>

### 6.2.5 Software

Symptom/Message	Possible cause	Remedy
A software error is shown on the display.	–	<ul style="list-style-type: none"> <li>Press the reset key.</li> </ul>
The password is incorrect.	<ul style="list-style-type: none"> <li>The password for the <i>Edit</i> mode and the <i>Adjustment</i> option has been mixed up.</li> <li>Password forgotten</li> </ul>	<ul style="list-style-type: none"> <li>Enter the correct password.</li> <li><i>Initial reset</i>, set the CAN bus address and termination of the thermal cyclers as listed below.</li> <li>Contact local Eppendorf distribution partner and request <i>Master key</i>.</li> </ul>

To prevent dispensing errors, regularly check the precision and accuracy of the pipette. You can use the "PICASO" software, version 2.3.18 or higher, to determine the maximum permissible systematic and random errors. If the pipette is used at an extremely high altitude, it must be adjusted to the ambient air pressure.



A Standard Operation Procedure (SOP) for the inspection is available on our webpage [www.eppendorf.com](http://www.eppendorf.com).



## **7 Maintenance**

- All single and multi-channel lower parts are wear parts. Clean them after contamination, use of aggressive chemicals and/or heavy stress. If the lower parts are worn or damaged, replace these parts.
- Faulty dispensing results are sometimes due to lack of maintenance.

### **7.1 Preserving the battery capacity**

The battery capacity can be preserved over the service life to a great extent.

#### **7.1.1 Longer periods without operation – with charger stand**

- ▶ Store the pipette in the plugged-in charger stand.  
The state of charge of the battery is automatically monitored and charged.

#### **7.1.2 Longer periods without operation – without charger stand**

1. Charge the battery completely if the pipette is not used for a longer period of time (> 4 weeks).
2. Recharge the battery completely every 3 months.

#### **7.1.3 Replacing the rechargeable battery**

1. Open the rechargeable battery compartment lid.
  2. Loosen the connector of the rechargeable battery from the connector socket.
  3. Remove the battery.
  4. Insert a new battery.
  5. Connect the connector of the Li-polymer rechargeable battery to the connector socket.
  6. Close the rechargeable battery compartment lid.
- In case of the pipette Xplorer plus, you will be prompted to set the date and time (see p. 24) .

## 7.2 Cleaning

---



### **NOTICE! Damage to device from unsuitable cleaning fluids or sharp or pointed objects.**

Unsuitable cleaning agents can damage the device.

- ▶ Never use corrosive cleaning agents, strong solvents or abrasive polishes.
- ▶ Check the compatibility with the materials used.
- ▶ Please note the information on chemical resistance.
- ▶ Do **not** clean the device with acetone or organic solvents with a similar effect.
- ▶ Do **not** clean the device with sharp objects.



### **NOTICE! Damage to the device due to penetration of liquids.**

- ▶ Do not set the pipette aside when the pipette tip is filled.
  - ▶ Do not allow any liquids to penetrate the inside of the housing.
- 

### 7.2.1 Cleaning and disinfecting the pipette

All single and multi-channel lower parts are wear parts. Clean them after contamination, use of aggressive chemicals and/or heavy stress. If the lower parts are worn or damaged, replace these parts.

1. Moisten a cloth with a cleaning agent and a decontamination agent.
2. Remove external contamination.
3. Moisten a new cloth with water.
4. Wipe down the housing.

## 7.2.2 Cleaning and disinfecting the lower part

### Prerequisites

- Heavy contamination caused by ingress of liquid must be removed.
  - Lower part has been removed and disassembled.
1. Remove piston grease.
  2. Rinse the lower part with cleaning agent or decontamination agent or let it soak.
    - i** Observe the contact time recommended by the manufacturer.
  3. Thoroughly rinse the lower part with demineralized water.
  4. Let it dry.
  5. Lubricate the piston or cylinder.
    - i** See instructions for use "Grease for pipettes".
  6. Assemble the lower part.

## 7.2.3 Sterilizing the pipette with UV light

The pipette can be sterilized with UV light at 254 nm.

## 7.3 Sterilizing or disinfecting the pipette

---



### **NOTICE! Damage to device from incorrect handling.**

- ▶ Only autoclave the lower part of the Xplorer pipette.
  - ▶ Do not use any additional disinfectants, decontamination agents or sodium hypochlorite when autoclaving the lower part.
  - ▶ When autoclaving the lower part, make sure that the temperature does not exceed 121°C.
  - ▶ Check the suitability of an agent and the manufacturer information about resistance to chemicals before using a disinfectant or decontamination agent. Please also note the pipette materials.
-

### 7.3.1 Autoclaving

All lower parts are steam autoclavable.

#### 7.3.1.1 Before autoclaving

1. Remove any contamination from the inside and outside of the lower part.
2. If you remove existing grease, slightly re-lubricate the piston seal using only the grease specified in the ordering information (see the instructions for use on our webpage [www.eppendorf.com/manuals](http://www.eppendorf.com/manuals)).

#### 7.3.1.2 Execution

Follow the operating manual of the autoclave manufacturer.

1. Autoclave at 121°C, 20 minutes, 1 bar pressure.
2. Put the lower part into the autoclave in such a way to ensure that the temperature at the lower part does not exceed 121°C.
3. For 5 mL and 10 mL pipettes: Remove the old protection filter. Include the filter sleeve and protection filter (only autoclave the protection filter once).
4. You can put the lower part into the autoclave as a whole unit or as individual parts.
5. Make sure that no parts of disassembled lower parts are confused during subsequent assembly (recommendation: use a plastic beaker for each lower part).

#### 7.3.1.3 After autoclaving

1. Cool the lower part down to room temperature and leave to dry. The piston does not need to be greased following autoclaving.
2. For 5 mL and 10 mL pipettes: Insert the protection filter in the filter sleeve. Insert the filter sleeve in the tip cone.
3. Carry out a gravimetric test to check that the Xplorer pipette is functioning.

### 7.3.2 Disinfection

1. Carefully wipe off the outer surfaces with disinfectant, DNA/RNA decontamination agents or 70% isopropanol.
2. You can wipe the outside of the tip cone and the ejector sleeve using a sodium hypochlorite solution of 4%.
3. After the exposure time of the sodium hypochlorite solution has elapsed, thoroughly remove it using demineralized water.

## 7.4 Replacing O-rings

The 100 µL, 300 µL and 1 200 µL multi-channel lower parts are equipped with O-rings. They are wear parts. Replace old, worn or damaged O-rings. Defective O-rings cause the incorrect positioning of the tips and dispensing errors.

### 7.4.1 Removing the O-ring

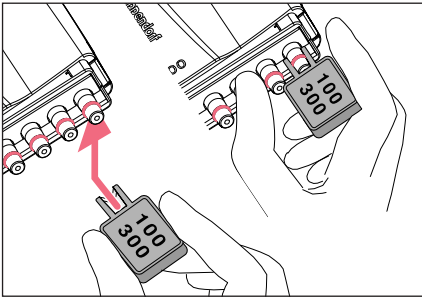

1. Push the opening of the multi-channel tool (included in the delivery package) against the tip cone from the side so that the sharp edge in the opening of the multi-channel tool is on top of the O-ring. Do not slide the multi-channel tool onto the cone! The figure shows the multi-channel tool for 100 µL and 300 µL. A separate multi-channel tool is available for 1 200 µL.
2. Supporting the multi-channel tool with your thumb, push it firmly against the tip cone. The O-ring is cut at one location.
3. Remove the multi-channel tool and the O-ring from the tip cone.

### 7.4.2 Mounting a new O-ring

**i** The assembly aid is only required for 100 µL and 300 µL multi-channel lower parts (smaller O-rings) and is therefore not included with the O-rings for 1200 µL.

1. Fit the assembly aid (shortened pipette tip, included in the O-ring delivery package) on the tip cone.
2. Push the new O-ring over the tip and onto the tip cone.
3. Check that the pipette tips are correctly positioned. Ensure that the tips are tightly sealed and properly aligned.

## 7.5 Xplorer disassembly and assembly

- i** For assembly, the serial number of the upper part and lower part must be identical.

### 7.5.1 Single-channel up to 1000 µL

#### 7.5.1.1 Removing the lower part

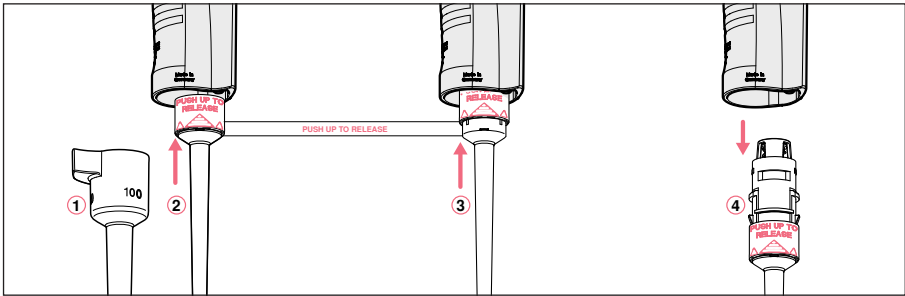

1. Keep the ejector pressed and remove the ejector sleeve ①.
2. ② and ③: On the lower part, slide the ring marked "PUSH UP TO RELEASE" up by about 5 mm until the lower part comes off.
3. ④: Remove the lower part from the upper part.

#### 7.5.1.2 Deactivating the spring-loading action of single-channel pipettes

You can deactivate the springs of the tip cones if you want to use pipette tips which require a higher attachment force. The spring-loading action of the tip cone can be deactivated by installing the locking ring. The locking ring is included in the delivery package.

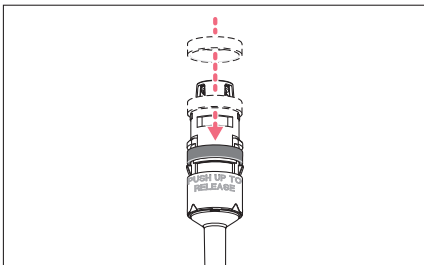

1. Push the black locking ring onto the lower part from the top by slightly squeezing the clamps on the lower part.
2. Insert the lower part into the upper part until it audibly engages.
3. Keep the ejector pressed. The ejector rod protrudes from the upper part.
4. Fit the ejector sleeve onto the ejector rod. If correctly fitted, it will engage slightly.

- i** Remove the locking ring to reactivate the spring-loading action.

### 7.5.1.3 Deactivating the spring-loading action of multi-channel pipettes

The spring-loading action of the tip cones can be deactivated in the 10  $\mu\text{L}$ , 100  $\mu\text{L}$  and 300  $\mu\text{L}$  multi-channel lower parts by installing 2 – 3 locking clips. The locking clips are part of the delivery package.

Prerequisites

- The multi-channel lower part is open and has been removed from the upper part.
- The channels have been removed.

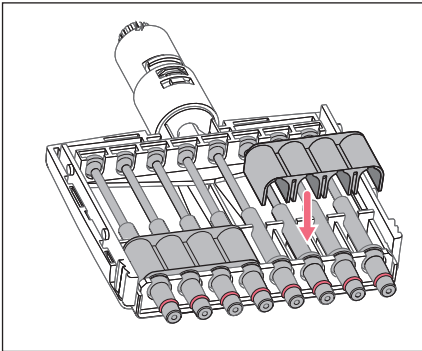

1. Remove the spring from the channels.
2. Insert the channels without springs.
3. Firmly press the locking clips onto the channels.
4. Assemble the pipette.

### 7.5.1.4 Opening and assembling the lower part (≤1000 µL)

#### Prerequisites

The piston is in the basic position.

- i** To avoid confusing the parts, only disassemble and assemble one pipette at a time.

#### Opening the lower part

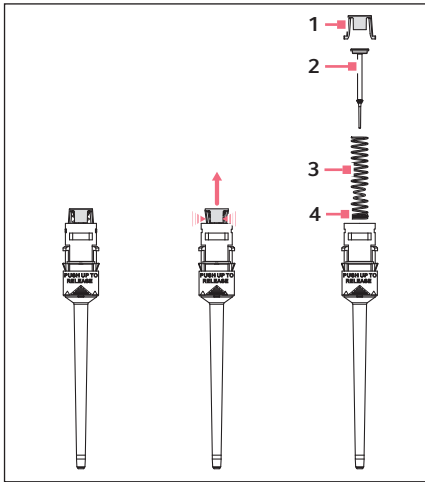

1. Slightly push the stop pins together on the piston mount (1).
2. Remove the piston mount.
3. Remove the piston (2) and the piston spring (3). The piston is under spring tension.

- i** The appearance of pistons and piston springs varies according to the individual volume versions.

#### Assembling the lower part

1. Carefully guide the piston and the piston spring into the cylinder. Make sure that the piston is guided correctly in the piston spring and the cylinder. There must not be any perceptible resistance. **Stop pushing as soon as any resistance is felt** This may indicate that the piston is not positioned correctly in the cylinder. There is a risk of bending the piston if too much force is applied. Carefully pull out the piston and repeat the process correctly. In the case of piston springs with double windings (4), these windings must point downwards.
2. Keep the piston and the piston spring pressed.
3. Keep the stop pins on the piston mount pressed with the other hand.
4. Mount the piston mount so that the two stop pins engage in their retainers.
5. Gently press a pipette tip against the inserted piston. The piston must move down in the cylinder without any noticeable resistance.



### Installing the lower part and ejector sleeve

1. Insert the lower part into the upper part until it audibly engages.
  2. Set the maximum volume and move the rocker up and down several times. There should not be any unusual running noises.
  3. Keep the ejector pressed. The ejector rod protrudes from the upper part.
  4. Fit the ejector sleeve onto the ejector rod. If correctly fitted, it will engage slightly.
  5. Carry out a gravimetric test of the systematic and random errors.
- This test ensures that no parts were confused during assembly and that the pipette has been assembled correctly.

### 7.5.2 5 mL and 10 mL single-channel

The piston must be in its basic position before separating the lower and upper part. Press the rocker down to move the piston to its basic position.

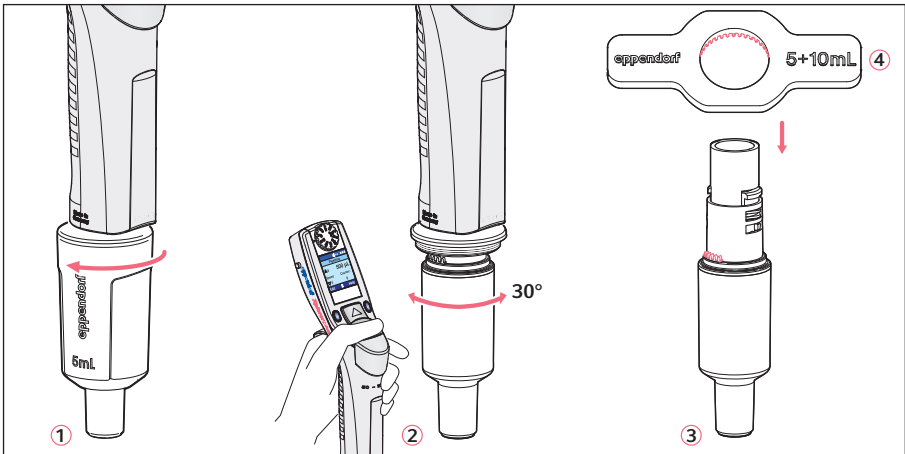

1. ①: Unscrew the ejector sleeve.
2. ②: Keep the ejector pressed and turn the lower part approximately 30° to the left or right. Pull the lower part down to cancel the magnetic coupling of the lower part. The lower part is separated from the upper part.
3. ③: Open the lower part: fit the pipette key ④ (included in the delivery package) onto the lower part. Hold the cylinder and unscrew it from the lower part. The cylinder with the tip cone is separated from the upper part of the lower part. The upper part of the lower part and the piston cannot be disassembled any further. See the next figure.

The lower part consists of the following:

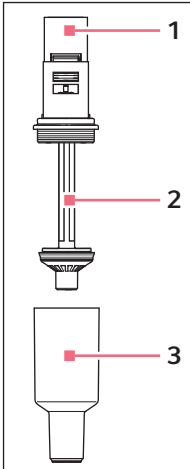

- 1 Upper part of the lower part**
- 2 Piston (with seal)**  
Piston with magnet
- 3 Cylinder and tip cone**

Assembly is performed in reverse order. Make sure that the magnet on the piston in the lower part is coupled with the magnet on the spindle in the upper part. After the assembly:

- ▶ Carry out a gravimetric test of the systematic and random errors.  
This test ensures that no parts were confused during assembly and that the pipette has been assembled correctly.
- ❗ For replacing an ejector sleeve, the 5 mL and 10 mL sizes are delivered with an ejector sleeve and ejector carrier. The lower part must be removed in order to install a new ejector carrier.

### 7.5.3 Multi-channel

#### 7.5.3.1 Loosen and open the 10 µL, 100 µL and 300 µL multi-channel lower part

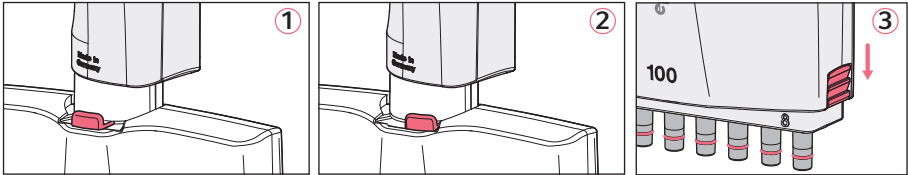

1. ① and ②: Slide the lever on the lower part to the left or right. Pull the lower part down to cancel the magnetic coupling of the lower part to the upper part. This separates the lower part from the upper part so that it can be removed.
2. Put down the lower part with the lever facing downward.
3. ③: Slide the two latches (right and left at the side) down using a coin. The lower part is still lying on the table with the lever facing downward.
4. Remove the cover plate facing upward and the integrated ejector rail.

Do **not** remove the ejector rail from the cover panel. The spring for the ejector rail may accidentally come off and get lost during this step.

#### 7.5.3.2 Removing and installing channels

Channels may only be removed and installed if the multi-channel lower part is separated from the upper part! The channels in the lower parts consist of a piston, cylinder and spring. The channels for 100 µL and 300 µL are equipped with an O-ring at the tip cone.

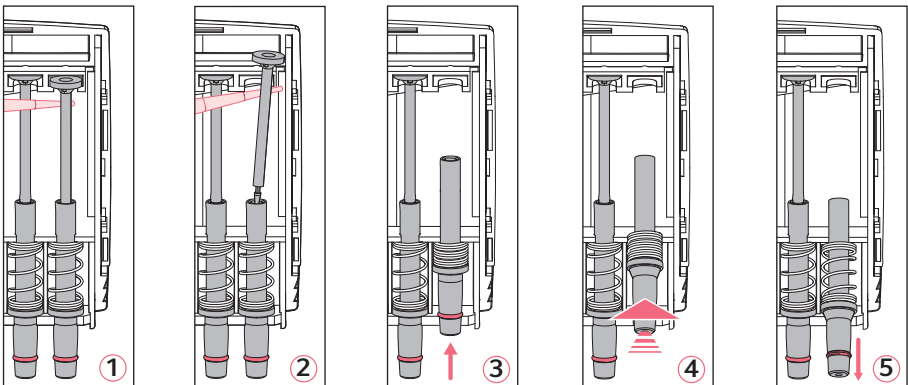

1. ① and ②: Position a pipette tip under the piston and carefully remove the piston from the upper rail.
2. Carefully pull the piston out in an upward direction. **Do not bend the piston.**
3. Hold the tip cone at the lower end and push it upward slightly ③. to compress the spring.
4. ④: Lightly lift the tip cone and release it from the lower rail.
5. ⑤: Relax the spring by letting the tip cone slide back above the lower rail.
6. Remove the tip cone, along with the cylinder and spring, from the upper rail. Before installation, slide the piston into the cylinder. Install the channels in reverse order.

### 7.5.3.3 Assembling the 10 - 300 µL multi-channel pipette

1. Fit the cover plate with the integrated ejector.
2. Push the latches upward.
3. For mounting, push the lower part into the upper part until it audibly engages. Make sure that the magnet on the piston actuator in the lower part is coupled with the magnet on the spindle in the upper part.
4. Carry out a gravimetric test of the systematic and random errors. This test ensures that no parts were confused during assembly and that the pipette has been assembled correctly.

### 7.5.3.4 Loosening and opening the 1200 µL multi-channel

The method of loosening the 1200 µL lower part matches that of loosening the 5 mL or 10 mL lower parts.

1. The piston must be in its basic position before loosening the lower part. Press the rocker down to move the piston into its basic position.
2. With the ejector pressed down, turn the lower part approximately 30° and pull down to cancel the magnetic coupling. This releases the lower part from the upper part.

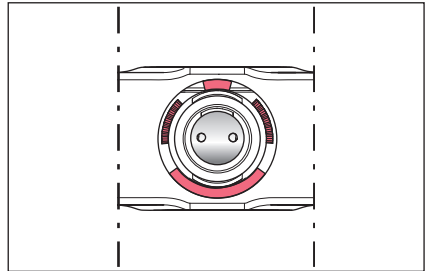
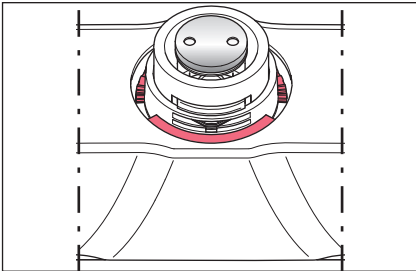

3. View the detached lower part from above. For this, slide the housing case part. Note the exact position of the red marked parts. **The red marked stops on the housing case and the red marked teeth on the inner part are adjacent.** If the stops and teeth are on top of each other after assembly, the housing case has been attached incorrectly.

### 7.5.3.5 Removing and installing 1200 µL channels

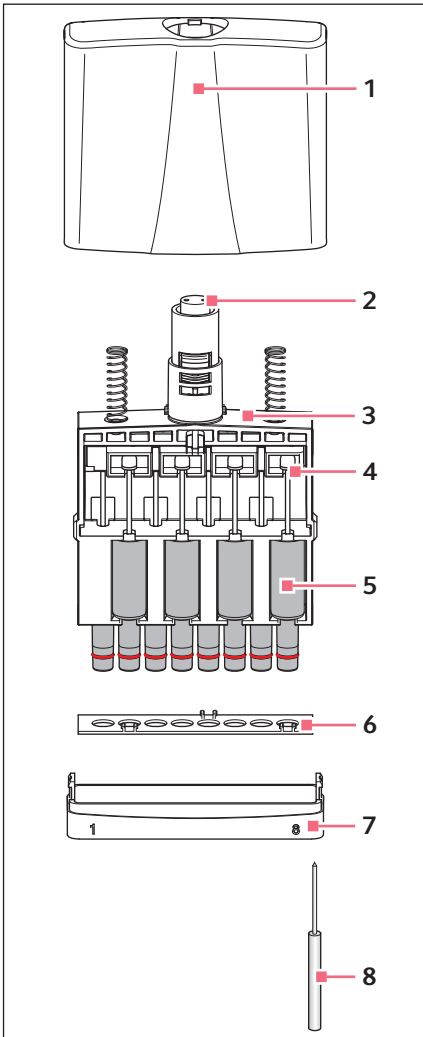

- 1 Housing case
- 2 Piston actuator
- 3 Inner part
- 4 Piston rod in the guiding rail of the piston actuator
- 5 Channel, consisting of a piston, a cylinder and a tip cone
- 6 Fixing strip
- 7 Base plate
- 8 Unlocking tool for 1200 µL lower part

Only disassemble the channels when the upper part is detached from the lower part.

1. Press the unlocking tool as far as it will go into the base plate.  
The base plate can now be detached by pulling gently at the side - at the side with the unlocking tool inserted. This loosens the base plate on the other side. Remove the base plate.
2. Take the inner part out of the housing case.
3. Loosen the fixing strip from the inner part. To do this, push the fixing strip away from the inner part in the area near the three fixing strip catches on the inner part.
4. Have a close look at the channel arrangement in the inner part. Four channels are accessible from each side. The tip cone of the channels is eccentric to the cylinder. The channels on the opposite side are therefore positioned "mirror-inverted". Ensure that the channels are inserted so that they are aligned in the center again during subsequent assembly.
5. Completely press down the guiding rail for the piston rods. Press the piston rod lightly out of the guiding rail and remove the channels.
6. Before installation, slide the piston into the cylinder. Install the channels in reverse order in accordance with the previously mentioned instructions. After installing the channels, carefully push the guiding rail with the piston rods upwards to ensure that the magnetic coupling of the lower and upper part can be safely reestablished.
7. Insert the reassembled lower part into the upper part. The lower part automatically snaps into the upper part on insertion. Make sure that the magnet on the piston actuator in the lower part is coupled with the magnet on the spindle in the upper part.
8. Carry out a gravimetric test of the systematic and random errors.  
This test ensures that no parts were confused during assembly and that the pipette has been assembled correctly.

## Maintenance

Eppendorf Xplorer®/Eppendorf Xplorer® plus  
English (EN)

### 7.6 Lubricating the piston or cylinder

The piston or the cylinder in the lower part of the pipette must be relubricated after cleaning or after decontamination.

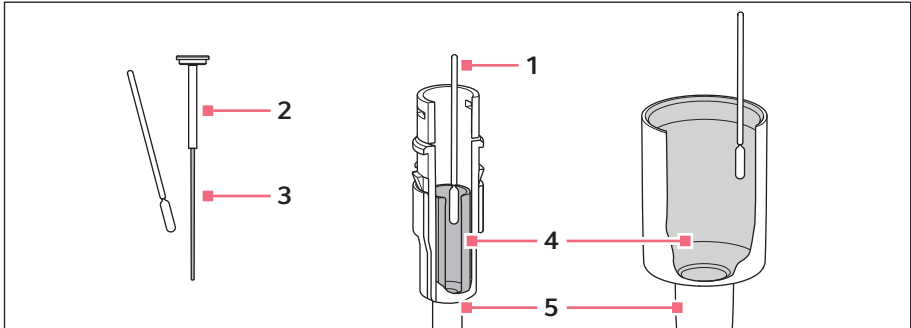

1 Cotton swab

2 Piston  $\leq 20 \mu\text{L}$

3 Running surface

1 Cylinder

1 Lower part  $> 20 \mu\text{L}$

#### 7.6.1 Lubricating the piston

Prerequisites

- For volumes  $\leq 20 \mu\text{L}$ .
- Lower part is disassembled.

1. Place a small amount of grease on the cotton swab.
2. Apply a thin film of grease to the running surface of the piston.  
The lower part can now be reassembled.

#### 7.6.2 Lubricating the cylinder

Prerequisites

- For volumes  $< 20 \mu\text{L}$ .
- Lower part is disassembled.

1. Place a small amount of grease on the cotton swab.
2. Apply a thin film of grease to the inner wall of the piston.  
The lower part can now be reassembled.

### 7.7 Maintenance

We recommend that you have all maintenance and servicing carried out by Eppendorf AG or Eppendorf service partners. No warranty is provided for any damage due to misuse or if the device has been opened by unauthorized persons.



## 8 Technical data

### 8.1 Measurement errors of the single-channel pipette

Model	Test tip epT.I.P.S.	Testing volume	Error of measurement			
			Systematic error		Random error	
			± %	± µL	± %	± µL
0.5 µL – 10 µL	0.1 µL – 20 µL medium gray 40 mm	1 µL	2.5	0.025	1.8	0.018
		5 µL	1.5	0.075	0.8	0.04
		10 µL	1.0	0.1	0.4	0.04
5 µL – 100 µL	2 µL – 200 µL yellow 53 mm	10 µL	2.0	0.2	1.0	0.1
		50 µL	1.0	0.5	0.3	0.15
		100 µL	0.8	0.8	0.2	0.2
15 µL – 300 µL	15 µL – 300 µL orange 55 mm	30 µL	2.5	0.75	0.7	0.21
		150 µL	1.0	1.5	0.3	0.45
		300 µL	0.6	1.8	0.2	0.6
50 µL – 1000 µL	50 µL – 1000 µL blue 71 mm	100 µL	3.0	3.0	0.6	0.6
		500 µL	1.0	5.0	0.2	1
		1000 µL	0.6	6.0	0.2	2
0.2 mL – 5 mL	0.1 mL – 5 mL violet 120 mm	0.5 mL	3.0	15.0	0.6	3
		2.5 mL	1.2	30.0	0.25	6.25
		5 mL	0.6	30.0	0.15	7.5
0.5 mL – 10 mL	1 mL – 10 mL turquoise 165 mm	1 mL	3.0	30.0	0.60	6.0
		5 mL	0.8	40.0	0.20	10.0
		10 mL	0.6	60.0	0.15	15.0



You can select a volume of up to 0.20 mL for the 5 mL pipette. The measurement errors in the volume range of 0.2 mL – 0.5 mL depend strongly on pipette handling.

**Technical data**

Eppendorf Xplorer®/Eppendorf Xplorer® plus  
English (EN)

**8.2 Measurement errors of the multi-channel pipette**

The measurement errors apply to 8-channel pipettes and 12-channel pipettes.

Model	Test tip epT.I.P.S.	Testing volume	Error of measurement			
			Systematic error		Random error	
			± %	± µL	± %	± µL
0.5 µL – 10 µL	0.1 µL – 20 µL medium gray 40 mm	1 µL	5.0	0.05	3.0	0.03
		5 µL	3.0	0.15	1.5	0.075
		10 µL	2.0	0.2	0.8	0.08
5 µL – 100 µL	2 µL – 200 µL yellow 53 mm	10 µL	2.0	0.2	2.0	0.2
		50 µL	1.0	0.5	0.8	0.4
		100 µL	0.8	0.8	0.25	0.25
15 µL – 300 µL	15 µL – 300 µL orange 55 mm	30 µL	2.5	0.75	1.0	0.3
		150 µL	1.0	1.5	0.5	0.75
		300 µL	0.6	1.8	0.25	0.75
50 µL – 1200 µL	50 µL – 1250 µL green 76 mm	120 µL	6.0	7.2	0.9	1.08
		600 µL	2.7	16.2	0.4	2.4
		1200 µL	1.2	14.4	0.3	3.6

**8.3 Test conditions**

Test conditions and test analysis in accordance with the standard ISO 8655, Part 6. The inspections are performed with a calibrated analytical balance with evaporation protection.

- Number of determinations per volume: 10
- Water according to ISO 3696
- Inspection at 20 °C – 25 °C ±0.5 °C
- Dispensing onto the tube inner wall
- Operating mode: PIP
- Speed level: 5

## **8.4 Technical data of the pipette**

### **8.4.1 Ambient conditions**

Operating temperature	5 °C – 40 °C
Relative humidity during operation	10 % – 95 %
Storage temperature	-5 °C – 45 °C
Relative humidity during storage	10 % – 95 %

### **8.4.2 Weight**

Weight without rechargeable battery and pipette tip	100 µL single-channel pipette approx.: 135 g (0.30 lb) 100 µL eight-channel pipette approx.: 213 g (0.47 lb)
---	---

### **8.4.3 Power supply**

Type	Power supply with power plug adapters
Input voltage	100 V – 240 V ±10 %
Output voltage	5 V
Current	1 A
Frequency	50/60 Hz

### **8.4.4 Rechargeable battery**

Type	Li-polymer rechargeable battery
Capacity	750 mAh/3.7 V
Charging time	approx. 3 h
Number of dispensings	approx. 1400 in <b>Pip</b> mode with a charged rechargeable battery and medium dispensing speeds with a ≤ 1000 µL single-channel pipette in continuous operation
Weight	approx. 20 g

**Technical data**

Eppendorf Xplorer®/Eppendorf Xplorer® plus  
English (EN)

**8.5 Dispensing speeds**

The following tables show the minimum duration required for the aspiration of the nominal volume at different speed levels. The actual duration may be longer. It depends, among other things, on the viscosity of the liquid, the ambient pressure, the temperature, or the tip opening. The dispensing speeds apply to single-channel pipettes and multi-channel pipettes from software version 2.06.00 onwards.

**8.5.1 Single-channel pipettes**

Speed level	Nominal volume					
	10 µL	100 µL	300 µL	1000 µL	5 mL	10 mL
1	12.0 s	12.0 s	12.0 s	12.0 s	12.0 s	12.0 s
2	8.0 s	8.0 s	8.0 s	8.0 s	8.0 s	8.0 s
3	4.0 s	4.0 s	4.0 s	4.0 s	6.0 s	6.0 s
4	2.8 s	2.8 s	2.8 s	2.8 s	4.8 s	4.8 s
5	2.2 s	2.2 s	2.2 s	2.2 s	3.6 s	3.6 s
6	1.6 s	1.6 s	1.6 s	1.6 s	3.2 s	3.2 s
7	1.2 s	1.2 s	1.2 s	1.2 s	2.8 s	2.8 s
8	0.9 s	0.9 s	0.9 s	0.9 s	2.6 s	2.6 s

**8.5.2 Multi-channel pipettes**

Speed level	Nominal volume			
	10 µL	100 µL	300 µL	1200 µL
1	12.0 s	12.0 s	12.0 s	12.0 s
2	8.0 s	8.0 s	8.0 s	8.0 s
3	4.0 s	4.0 s	4.0 s	4.0 s
4	2.8 s	2.8 s	2.8 s	2.8 s
5	2.2 s	2.2 s	2.2 s	2.2 s
6	1.6 s	1.6 s	1.6 s	1.6 s
7	1.2 s	1.2 s	1.2 s	1.2 s
8	0.9 s	0.9 s	0.9 s	1.0 s

## 9 Transport, storage and disposal

### 9.1 Decontamination before shipment

---



**CAUTION! Use of a contaminated device may result in personal injuries and damage to the device.**

- ▶ Clean and decontaminate the device in accordance with the cleaning instructions before shipping or storage.
- 

Hazardous substances are:

- solutions presenting a hazard to health
  - potentially infectious agents
  - organic solvents and reagents
  - radioactive substances
  - proteins presenting a hazard to health
  - DNA
1. Please note the information in the document "Decontamination certificate for product returns".  
It is available as PDF document on our website [www.eppendorf.com/manuals](http://www.eppendorf.com/manuals).
  2. Enter the serial number of the device in the decontamination certificate.
  3. Enclose the completed decontamination certificate for returned goods with the device.
  4. Send the device to Eppendorf AG or an authorized service center.

## 9.2 Storage

**NOTICE! Damage to device due to incorrect storage.**

- ▶ Remove the rechargeable battery if you will not be using the device for longer periods of time.
- ▶ Select a secure storage location.
- ▶ Do not expose the device to aggressive gases over a longer period of time.

	<b>Air temperature</b>	<b>Relative humidity</b>	<b>Atmospheric pressure</b>
In transport packaging	-25 °C – 55 °C	10 % – 95 %	70 kPa – 106 kPa
Without transport packaging	-5 °C – 45 °C	10 % – 95 %	70 kPa – 106 kPa

## 9.3 Disposal

In case the product is to be disposed of, the relevant legal regulations are to be observed.

**Information on the disposal of electrical and electronic devices in the European Community:**

Within the European Community, the disposal of electrical devices is regulated by national regulations based on EU Directive 2002/96/EC pertaining to waste electrical and electronic equipment (WEEE).

According to these regulations, any devices supplied after August 13, 2005, in the business-to-business sphere, to which this product is assigned, may no longer be disposed of in municipal or domestic waste. They are marked with the following symbol to indicate this:

As disposal regulations may differ from country to country within the EU, please contact your supplier if necessary.





**WARNING! Risk of explosion and fire due to overheated rechargeable batteries and batteries.**

- ▶ Do not heat rechargeable batteries and batteries to over 80°C and do not throw them into fire.

---

**Disposing of accumulators and batteries**

Do not dispose of accumulators and batteries as household waste.  
Dispose of accumulators and batteries according to the locally applicable legal regulations.



**Ordering information**Eppendorf Xplorer®/Eppendorf Xplorer® plus  
English (EN)**10 Ordering information**Additional ordering information (e. g., spare parts and accessories) can be found on our webpage [www.eppendorf.com/manuals](http://www.eppendorf.com/manuals).

<b>Order no. (International)</b>	<b>Order no. (North America)</b>	<b>Description</b>
4861 000.015	4861000015	<b>Eppendorf Xplorer</b> single-channel medium gray, 0.5 – 10 µL
4861 000.023	4861000023	yellow, 5 – 100 µL
4861 000.031	4861000031	orange, 15 – 300 µL
4861 000.040	4861000040	blue, 50 – 1000 µL
4861 000.058	4861000058	violet, 0.2 – 5 mL
4861 000.066	4861000066	turquoise, 0.5 – 10 mL
4861 000.104	4861000104	<b>Eppendorf Xplorer</b> 8 channel medium gray, 0.5 – 10 µL
4861 000.120	4861000120	yellow, 5 – 100 µL
4861 000.147	4861000147	orange, 15 – 300 µL
4861 000.163	4861000163	green, 50 – 1200 µL
4861 000.112	4861000112	<b>Eppendorf Xplorer</b> 12-channel medium gray, 0.5 – 10 µL
4861 000.139	4861000139	yellow, 5 – 100 µL
4861 000.155	4861000155	orange, 15 – 300 µL
4861 000.171	4861000171	green, 50 – 1200 µL
4861 000.708	4861000708	<b>Eppendorf Xplorer plus</b> single-channel medium gray, 0.5 – 10 µL
4861 000.716	4861000716	yellow, 5 – 100 µL
4861 000.724	4861000724	orange, 15 – 300 µL
4861 000.732	4861000732	blue, 50 – 1000 µL
4861 000.740	4861000740	violet, 0.2 – 5 mL
4861 000.759	4861000759	turquoise, 0.5 – 10 mL



Order no. (International)	Order no. (North America)	Description
4861 000.767	4861000767	<b>Eppendorf Xplorer plus</b> 8 channel medium gray, 0.5 – 10 µL yellow, 5 – 100 µL orange, 15 – 300 µL green, 50 – 1200 µL
4861 000.783	4861000783	
4861 000.805	4861000805	
4861 000.821	4861000821	
4861 000.775	4861000775	<b>Eppendorf Xplorer plus</b> 12-channel medium gray, 0.5 – 10 µL yellow, 5 – 100 µL orange, 15 – 300 µL green, 50 – 1200 µL
4861 000.791	4861000791	
4861 000.813	4861000813	
4861 000.830	4861000830	

**Index****A**

## Adjustment

1-point adjust.....	58
2-point adjust.....	58
3-point adjust.....	58
Altitude.....	57
epTIPS long.....	57
Ethanol 75%.....	56
Factory settings.....	56
Glycerol 50%.....	56

## Assembly

10 µL, 100 µL and 300 µL multi-channel lower part.....	76
1200 µL multi-channel lower part....	78
5 mL and 10 mL single-channel lower part.....	73
Single-channel lower part up to 1000 µL.....	72

Automatic dispensing..... 36

**B**

## Blow

Blow-out.....	38
---------------	----

## Blow-out

Blow.....	38
-----------	----

**C**

Charging carousel..... 23

Charging stand..... 23

Color coding..... 32

**D**

Diluting.....44

## Disassembly

10 µL, 100 µL and 300 µL multi-channel lower part.....	75
1200 µL multi-channel lower part....	77
5 mL and 10 mL single-channel lower part.....	73
Single-channel lower part up to 1000 µL.....	70

Disinfection.....67

Dispensing.....37

Dispensing speeds.....84

Display.....17

Disposal.....86

**E**

Edit.....49

Edit mode.....27

**F**

## Factory setting

Initial reset.....	60
--------------------	----

Features.....16

Fixed volume.....52

Footer.....19

**H**

Header.....18

**L**

## Lithium-polymer rechargeable battery

Connect.....	21
--------------	----

Locking clip.....71

Locking ring.....70

**M**

Main field .....	19
Main illustration	
Single-channel pipette.....	14
Main illustration	
Multi-channel pipette .....	15
Mains/power supply device assembly....	21
Maintenance .....	80
Manual pipetting .....	42
Measurement errors	
Multi-channel .....	82
Single-channel.....	81
Multiple aspiration (Aspirate).....	43

**O**

O-ring	
O-ring .....	69, 69
On/Off key.....	14
Operating mode.....	25
Automatic dispensing.....	36
Diluting.....	44
Dispensing.....	37
Manual pipetting .....	42
Multiple aspiration (Aspirate).....	43
Pipetting .....	38
Pipetting and mixing .....	41
Reverse pipetting .....	47
Sequential dispensing .....	46
Sequential pipetting .....	48
Option	
<i>Adjustment</i> .....	56
<i>Brightness</i> .....	55
<i>Counter</i> .....	55
<i>Date</i> .....	60
<i>Date and Time</i> .....	60
<i>Ejector reset</i> .....	55
<i>General help</i> .....	53
<i>History</i> .....	55
<i>Language</i> .....	59
<i>Personalization</i> .....	59
<i>Pswrd. protection</i> .....	58
<i>Rocker setting</i> .....	55
<i>Service</i> .....	59

<i>Service interval</i> .....	59
<i>Sound level</i> .....	55
<i>Time</i> .....	60
<i>Volume limit</i> .....	53

**P**

Parameter	
Set .....	27
Pipette tips	
Recommendation .....	31
Pipetting.....	38
Reverse.....	40
Standard.....	38
Pipetting and mixing.....	41
Program .....	49

**R**

Rechargeable battery	
Charge.....	22
Replace channel	
10 µL up to 300 µL multi-channel lower part.....	75
1200 µL multi-channel lower part.....	78
Reset key .....	14, 61
Reverse pipetting .....	47

**S**

Selection dial.....	14
Sequential dispensing.....	46
Sequential pipetting.....	48
Special.....	43
Spring-loading action.....	70
Status bar .....	19
Sterilization .....	67
Storage .....	86
Switching off .....	24
Switching on .....	24

**U**

USB port ..... 14

Using pipette tips ..... 32

**V**

Volume limit ..... 33

**W**

Warranty ..... 20

# Declaration of Conformity

The product named below fulfills the requirements of directives and standards listed. In the case of unauthorized modifications to the product or an unintended use this declaration becomes invalid.

**Product name:**

Eppendorf Xplorer®, Eppendorf Xplorer® plus  
including charging adapter

**Product type:**

Electronic pipette

**Relevant directives / standards:**

2014/35/EU EN 61010- 1  
2014/30/EU EN 55011, EN 61326- 1  
2011/65/EU EN 50581  
EN ISO 8655- 1, EN ISO 8655- 2, EN ISO 8655- 5, EN ISO 8655- 6

Date: February 16, 2016



Management Board



Portfolio Management

Your local distributor: [www.eppendorf.com/contact](http://www.eppendorf.com/contact)  
Eppendorf AG · 22331 Hamburg · Germany  
[eppendorf@eppendorf.com](mailto:eppendorf@eppendorf.com)

Eppendorf® and the Eppendorf logo are registered trademarks of Eppendorf AG, Germany.  
U.S. Design Patents are listed on [www.eppendorf.com/ip](http://www.eppendorf.com/ip).  
All rights reserved, incl. graphics and pictures. Copyright 2015 © by Eppendorf AG.

[www.eppendorf.com](http://www.eppendorf.com)

ISO 9001  
Certified

ISO  
13485  
Certified

ISO  
14001  
Certified





# Evaluate Your Manual

Give us your feedback.

[www.eppendorf.com/manualfeedback](http://www.eppendorf.com/manualfeedback)

**Your local distributor: [www.eppendorf.com/contact](http://www.eppendorf.com/contact)**

Eppendorf AG · 22331 Hamburg · Germany

[eppendorf@eppendorf.com](mailto:eppendorf@eppendorf.com) · [www.eppendorf.com](http://www.eppendorf.com)